

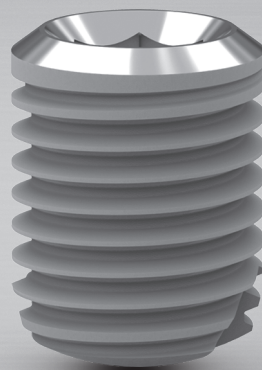

Surgical procedure manual

Zinic[®]SHORTY



ZiNiC[®]SHORTY

Surgical procedure manual



Sede Central Europa | Europe Headquarters
Ziacom Medical SLU
Calle Búhos, 2
28320 Pinto - Madrid - ESPAÑA
Tfno: +34 91 723 33 06
info@ziacom.es - www.ziacom.es

Sede Central América | America Headquarters
Ziacom Medical USA LLC
333 S.E. 2nd Avenue, Suite 2000
Miami, FL 33131 - USA
Tel: +1 (786) 224 - 0089
info.usa@ziacom.es - www.ziacom.es



Important information

Read this carefully before using ZIACOM® products

General information

This document contains basic information about the use of ZIACOM® Dental Implant Systems, henceforth, ZIACOM® products. This document has been written as a quick reference guide for the professional in charge of the treatment, henceforth, "User". It does not provide sufficient indications and technical specifications for the use of ZIACOM® products. It is neither an alternative nor a substitute for specialised training and professional clinical experience.

ZIACOM® products must be used in accordance with proper treatment planning and in strict accordance with the surgical and prosthetic protocols established by the manufacturer. Before using a ZIACOM® product, please read the specific surgical and prosthetic protocols as well as the operating and maintenance instructions carefully. You can consult them on our website www.ziacom.es or request them from your nearest ZIACOM® authorised distributor.

Information about responsibility, safety and guarantee.

The indications for use and handling of ZIACOM® products are based on the published international literature, current clinical standards and our clinical experience with our products and should therefore be understood as general indicative information. The handling and use of ZIACOM® products, as they are beyond the control of Ziacom Medical SLU, are the sole responsibility of the user. Ziacom Medical SLU, its subsidiaries and/or its official distributors decline all responsibility, express or implicit, totally or partially, for any possible damage or loss caused by the improper handling of the product or by any other fact not contemplated in its protocols and manuals for the correct use of its products.

The user of the product must ensure that the ZIACOM® product used is suitable for the intended procedure and purpose. Neither these instructions for use nor the protocols for working with or handling the products relieve the user of this obligation. The use, handling and clinical application of ZIACOM® products must be carried out by qualified professional personnel with the necessary qualifications according to the current legislation of each country.

The use, handling and/or application, fully or in part, of ZIACOM® products in any of their manufacturing phases by unqualified personnel or without the necessary qualifications, automatically voids any type of guarantee and may cause serious damage to the patient's health.

ZIACOM® products are part of an own system, with its design features and working protocols, which include dental implants, abutments and prosthetic components and surgical or prosthetic instruments. The use of ZIACOM® products in combination with elements or components from other manufacturers can lead to treatment failure, serious damage to bone structures, tissue and patient health, as well as undesired cosmetic results. For this reason, only original ZIACOM® products should be used.

The clinician, who is responsible for the treatment, is solely responsible for ensuring that original ZIACOM® products are used and that they are used in accordance with the instructions for use and the corresponding handling protocols throughout the entire implant treatment process. The use of ZIACOM® components, instruments or any other non-original product used alone or in combination with any of the original ZIACOM® products will automatically void any guarantee on the original ZIACOM® products.

Please consult the ZIACOM® Guarantee Program on our website www.ziacom.es

Warning Non entire ZIACOM® products are available in all countries. Please consult their availability.

ZIACOM®, Zinic®, Zinic®MT, Zinic®Shorty, OEX®, OEX®MT, OEX®ST, OIN®, OIN®MT, OIN®ST, OXP®, ZMK®, ZMR®, OST®, ZM1®, ZM1®MT, ZM4®, ZM4®MT, ZM8®, ZM8®N, ZM8®S, Galaxy®, ZV2®, Zinic®3D, TPlus®, XPlus®, ZPlus®, Z2Plus®, 3DPlus®, Kiran®, Kirator®, ZM-Equator®, Basic®, XDrive®, ZiaCam®, ZIACOR®, Tx30®, Zellplex®, ZellBone®, PlexGuide®, OsseosBCP®, OsseosTCP®, Osseolife®, Osseonova®, DSQ®, Zitium® and all logos are trademarks of Ziacom Medical SLU.

The brand ZIACOM® is a registered trademark as some of its products mentioned or not in this catalogue. Ziacom Medical SLU reserves the right to modify, change and remove any of the products, prices or technical specifications which are referenced in this document or in any of its catalogues without prior notice. All rights reserved. It is strictly forbidden the reproduction or publication of this document, in whole or in part, in any form or by any means, without prior written permission of Ziacom Medical SLU.



Index

Zinic® Shorty | Internal hexagonal connection implants

Features	06
Usage recommendations	07
Packaging and product handling	08
ZPlus® Mount	08
Z2Plus® Mount	10
ZIACOM® No Mount	12

Zinic®Shorty surgical procedure 14

General considerations	16
Steps for placing Zinic®Shorty implants	18
Implant insertion	20
ZPlus® Mount	20
Z2Plus® Mount	22
ZIACOM® No Mount	24
Soft tissue conditioning	25
Surgical drilling protocol	26
ZPlus®Mount	26
Z2Plus® Mount	27
ZIACOM® No Mount	28
General recommendations	29
Cleaning, disinfection and sterilization	30
General sales conditions	31

ZINIC[®]SHORTY

Internal hexagonal connection implants

- **Features**
 - » Connection
 - » Cortical area
 - » Body
- **Available diameters and lengths**
- **Usage recommendations**
 - » Clarifications on measurement and drilling techniques
- **ZPlus[®] Mount**
 - » Packaging and product handling
 - » Features and references
- **Z2Plus[®] Mount**
 - » Packaging and product handling
 - » Features and references
- **ZIACOM[®] No Mount**
 - » Packaging and product handling
 - » Features and references

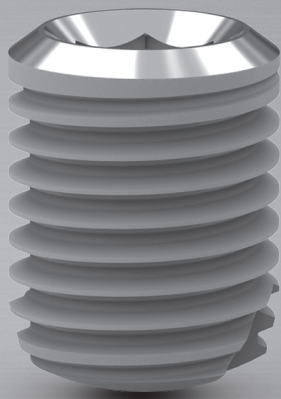

Zinic[®]SHORTY

Features

CONNECTION

- » Internal hexagonal connection
- » 1,5mm prosthetic hexagon depth: improves longitudinal forces distribution
- » Conical bevel: reduces infiltration
- » Friction fit: reduces micro-movements
- » Platform switch: soft tissue formation and emergence profile shaping

CORTICAL AREA

- » Macro-design: excellent cortical compression
- » 0,4mm mechanised area on bevel

BODY

- » Reduced angle lead threads: provide stability during insertion and increase BIC (bone-implant contact)
- » Optimised morphology: high primary stability

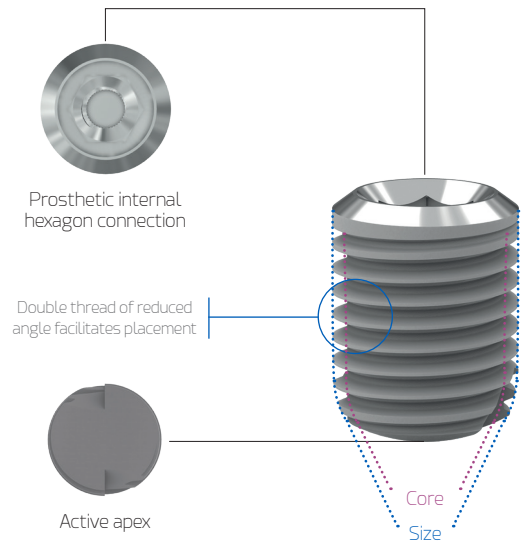

Available diameters and lengths

Lengths in mm

● **RP** (Ø4,75mm)
ØPlatform 3,50mm



● **WP** (Ø5,25mm)
ØPlatform 4,50mm



Implant coronal area measurements

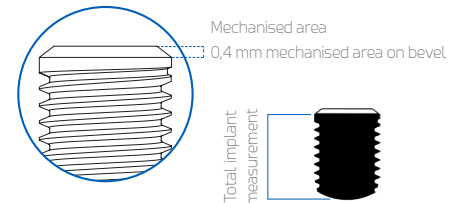

Tubes usage:

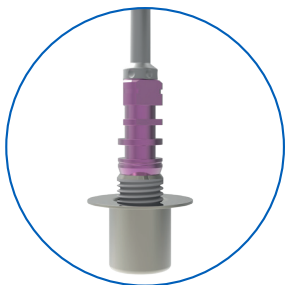

STEP 1:
place the implant in the tube

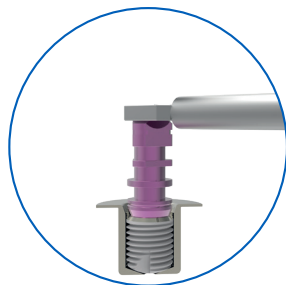

STEP 2:
position the block key

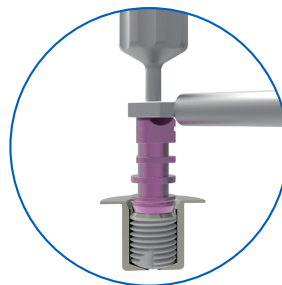

STEP 3:
remove the screw and the Mount



STEP 4:
use the insertion key direct to implant

Usage recommendations

All implant planning must respect the natural biomechanical stability of the oral cavity and allow the natural emergence of the dental crown, through the soft tissue, by means of an implant with a prosthetic platform whose diameter is proportionally smaller than the emergence diameter of the tooth to be restored. The implantologist must assess the quantity and quality of bone in the recipient area of the implant and consider the need for prior or simultaneous bone regeneration as appropriate.

ZIACOM® has a broad range of implants to cover every restoration possibilities.

In the odontogram, the circles identified with letters, represent the diameters and platforms of the implants recommended for those dental positions. These recommendations apply to teeth replacement with single restoration, bridges and partial or total implant-retained tissue-supported prosthesis.

Remember to maintain minimum distances between adjacent implants and/or implants and teeth, to preserve papillae, bone vascularisation and natural emergence profiles.

The choice of the appropriate implant, in each case, is the exclusive responsibility of the clinician. Ziacom Medical recommends taking into account warnings based on scientific evidence contained in product catalogues and website.

CLARIFICATIONS ON MEASUREMENT AND DRILLING TECHNIQUES:

- **IMPLANT SIZE:** identifies implant diameter and length.
- **IMPLANT BODY:** implant core diameter.
- **DRILL MEASUREMENT:** corresponds to the drill diameter.
- **UNDERSIZED DRILLING TECHNIQUE:** surgical site preparation with final drill of lower diameter than the implant body. Technique associated with high insertion torque and increased primary stability.
Important: possible increased risk of bone necrosis due to pressure.
- **SIMPLIFIED DRILLING TECHNIQUE:** technique proposed by Coelho and Cols in 2013 (1). It consists of the use of pilot drill and final drill corresponding to the size of the implant. It reduces drilling sequence but with risk of bone necrosis due to thermal increase.

(1) The effect of simplifying dental implant drilling sequence on osseointegration: an experimental study in dogs.

Giro G1, Tovar N, Marin C, Bonfante EA, Jimbo R, Suzuki M, Janal MN, Coelho PG. Int J Biomater. 2013;2013:230310. doi: 10.1155/2013/230310. Epub 2013 Jan 30.

Odontogram

ZINIC®SHORTY

Implant diameter (1)

● RP ● WP
Ø4,75mm Ø5,25mm

(1) Diameters are available for analog platforms.

Coronal implant diameter

● RP ● WP
Ø3,50mm Ø4,50mm

- Implants marked with *** are recommended to be splinted. In case of single-tooth restorations, relieve them from occlusal loads.

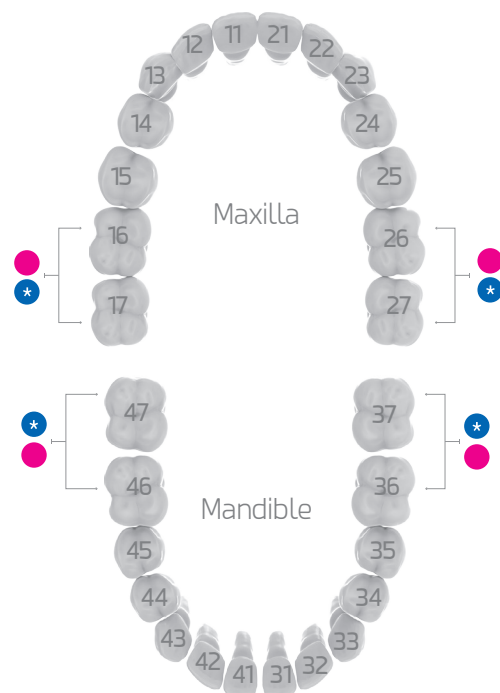

ZPlus® Mount

Packaging and product handling

1. Click on the word "PRESS" and rip the carton.



2. Remove the cardboard flap and take out the blister.



3. Carefully remove the blister seal from the implant



4. Drop the vial on the sterile cloth in surgical area.



Implant removal

5. Hold the vial horizontally with one hand and insert the manual or CA adapter into the ZPlus® Mount.

Ref. XSMIN,
Ref. TSMIN,
Ref. TLMIN,
Ref. 01MMIN or
Ref. 02MMIN

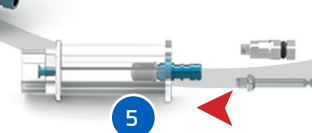

7. Remember to remove the label from the implant to paste it onto the patient's implantation document and thus maintain product traceability



6. Remove the implant-ZPlus® assembly by pulling it up vertically to the vial.

Ref. XSMIN,
Ref. TSMIN or
Ref. TLMIN + MADW10



Ref. XSMIN or
Ref. TSMIN or
Ref. TLMIN + RATC50

Ref. 01MMIN or
Ref. 02MMIN + Contra-angle

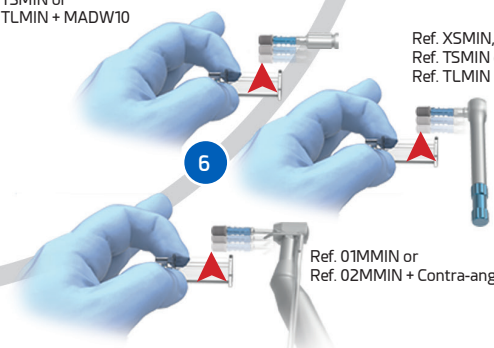

ZIACOM® ZPlus® are packaged in a sealed carton box with a product label for immediate identification. It contains:

- **Instructions for Use (IFU).**
- **Implant blister:** heat-sealed, with product identification labels for correct traceability. Its flap facilitates opening in clinic and prevents accidental opening. Contains: implant carrier vial.
- **Implant carrier vial:** contains suspended implant attached to the Mount + final screw + implant cover screw threaded on the back.
- **Product identification label data:** product reference, platform, implant diameter and length, product description, batch number, product manufacturer, expiration date and product identification symbols.

Note. Do not open the sterile container until the time of implant placement.

Description of the symbology used

- | | |
|---|---|
| <ul style="list-style-type: none"> CE 1500 MDD CE certification and notified body MD Name of the medical device LOT Number of product batch Patient information website UDI Unique device identification STERILE B Beta sterile product Temperature restriction Caution, consult accompanying documents | <ul style="list-style-type: none"> Do not resterilise Do not use if the packaging is damaged Non-reusable product Consult the instructions for use Expiry date of the product Date of manufacture Product manufacturer Rx Only Caution: federal law prohibits dispensing without prescription |
|---|---|

Features and references

The **ZPlus®** is designed as a titanium grade 5 ELI (sanitary use) multifunction abutment. **ZPlus®** improves the handling of the implant during the surgery and incorporates new functions of use. In addition, the fundamental concept of the **ZPlus®** is the reduction of treatment costs, as it can be used as a Mount, impression transfer or provisional abutment for cement-screwed.

The **ZPlus®** Mount is available in all **ZIACOM®** implant ranges (except ZM8®N, ZM8®S, Galaxy®, ZV2®, ZMK® and ZMR®).

Attention

ZPlus® can be used as provisional abutment. **ZPlus®** should be prepared extraorally, by mounting in an analogue, preferably on a laboratory model or assembled on a clamping handle.

The structural integrity of the Mount and its screw, which have not been deformed or damaged by excessive insertion torque or forced removal handling, must be confirmed. Check that **ZPlus®** cover screw is properly seated and that the connection to the analogue is correctly adjusted.

Important

Always place the implant according to the specifications of the surgical protocol, to protect the Mount and its screw from possible damage that may prevent its later use as an impression abutment and/or provisional abutment. *Each **ZPlus®** should only be used in the same implant that the Mount belonged to. You should keep the **ZPlus®** and its screw with patient identification, detailing the reference and lot of the implant to avoid confusion and exchange the Mounts. The **ZPlus®** is supplied with 3 flat faces. At the end of the implant insertion, make sure that one of them matches the vestibular area.*

ZPlus® Mount uses

As a Mount

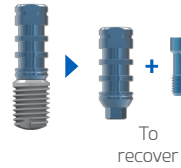

As impression transfer

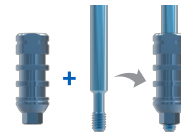

As provisional abutment

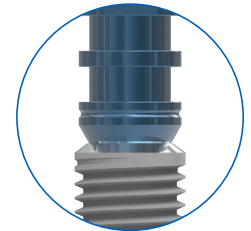
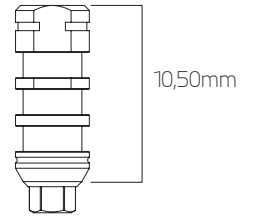
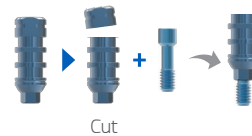

Implant view + Mount

ZPlus® option. References

	IMPLANT			PLATFORM				
	Ø (mm)	Ø Core (mm)	Length	REF.	Type	Ø (mm)	Internal metric	
Zinic [®] SHORTY	4,75	4,00	6,0 mm	ZSS4756HT	● RP	3,50	M1,80	
			7,0 mm	ZSS4757HT				
	5,25	4,50	6,0 mm	ZSS5256HT	● RP	4,50	M1,80	
			7,0 mm	ZSS5257HT				

(1) Depth of the internal hexagon. (2) Distance between internal hex faces. (3) Platform work diameter.

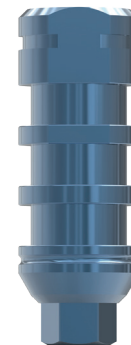

Cover screw*



Platf.	Length (L)	Reference
●	4,20 mm	ZRPT
●	4,20 mm	ZWPT

Anodised ■ RP ■ WP



* Screw already included in each implant.

Z2Plus® Mount

Packaging and product handling

1. Click on the word "PRESS" and rip the carton.



2. Remove the cardboard flap and take out the blister.



3. Carefully remove the blister seal from the implant.



4. Drop the vial on the sterile cloth in surgical area.



5. Hold the vial with one hand in a vertical position. Remove the cap by turning it vertically.

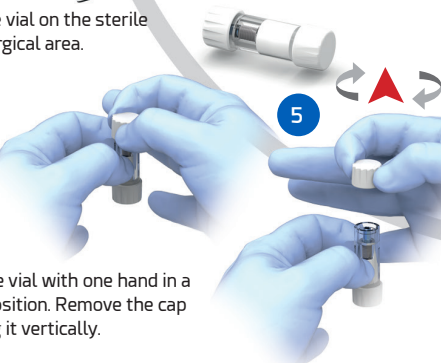

Implant removal

6. Hold the vial vertically with one hand and place the insertion key, for ratchet or CA, into the Z2Plus® Mount.

Ref. XSMIN,
Ref. TSMIN,
Ref. TLMIN,
Ref. 01MMIN or
Ref. 02MMIN



8. Remember to remove the label from the implant to paste it onto the patient's implantation document and thus maintain product traceability.

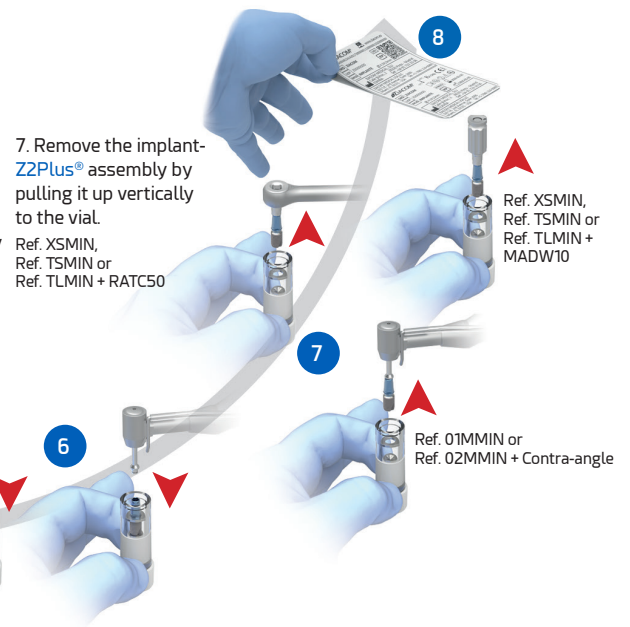

7. Remove the implant-Z2Plus® assembly by pulling it up vertically to the vial.

Ref. XSMIN,
Ref. TSMIN or
Ref. TLMIN + RATC50

Ref. XSMIN,
Ref. TSMIN or
Ref. TLMIN +
MADW10

Ref. 01MMIN or
Ref. 02MMIN + Contra-angle

ZIACOM® Z2Plus® are packaged in a sealed carton box with a product label for immediate identification. It contains:

- **Instructions for Use (IFU).**
- **Implant blister:** heat-sealed, with product identification labels for correct traceability. Its flap facilitates opening in clinic and prevents accidental opening. Contains: implant carrier vial + Snap-On plastic transfer
- **Implant carrier vial:** contains vertically suspended implant attached to the Mount + final screw + implant cover screw on the back.
- **Product identification label data:** product reference, platform, implant diameter and length, product description, batch number, product manufacturer, expiration date and product identification symbols.

Note. Do not open the sterile container until the time of implant placement.

4.75X6mm

ZIACOM®

MD ZSS4756HTN
LOT Z0000000
1 Unid RP Ø4.75X6mm

Z2Plus®

Snap On STERILE R

ZINIC® SHORTY

ES ES
EN EN
DE DE
FR FR
IT IT
PT PT

ZIACOM MEDICAL, S.L.U. Pinar - Madrid
C/Alfonso de Ebro, 2
28042 Madrid, Spain
Tel: +34 91 723 33 06

ZIACOM MEDICAL USA, LLC
353 S.E. 7nd Avenue, Suite 2000
Miami, FL 33131 - USA
Tel: +1 (786) 224-0089

(01)08435481258442(17)000000(11)000000(10)Z0000000

www.ziacom.es

UDI

Rx Only

Description of the symbology used

- | | | | |
|-----------|---|---------|--|
| CE | MDD CE certification and notified body | ☒ | Do not resterilise |
| MD | Name of the medical device | ☒ | Do not use if the packaging is damaged |
| LOT | Number of product batch | ☒ | Non-reusable product |
| 🌐 | Patient information website | 📖 | Consult the instructions for use |
| UDI | Unique device identification | 📅 | Expiry date of the product |
| STERILE R | Beta sterile product | 🏭 | Date of manufacture |
| 🌡️ | Temperature restriction | 🏢 | Product manufacturer |
| ⚠️ | Caution, consult accompanying documents | Rx Only | Caution: federal law prohibits dispensing without prescription |

Features and references

The new **Z2Plus®** has been designed as a titanium grade 5 ELI (sanitary use) multifunction abutment. Its three functions include: Mount, sculptable straight abutment for easy preparation and transfer for Snap-On technique.

Z2Plus® in its application as a transfer for Snap-On, allows an easy and quick impression in the surgical act, allowing to advance the manufacture of the restoration with less time of dental office and fewer clinical appointments, with the consequent saving of costs in the treatment. **Z2Plus®** is supplied with one flat face. At the end of the implant insertion, make sure that the flat face matches the vestibular area.

The Snap-On impression transfer, which is supplied with **Z2Plus®**, has an internal plane, which is guided by the upper grooves and aligned with the plane of the **Z2Plus®** abutment, and after sliding by pressure, its inner groove fits into the lower ring of the abutment, ensuring secure retention for the dragging impression and subsequent replacement of the **Z2Plus®**.

The impression transfer has an oval top which must coincide with the vestibular area (Figures 1 and 2).

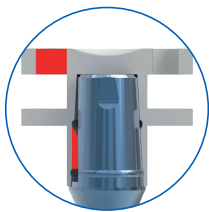

Fig. 1: Side view of the Snap-On transfer, alignment of the abutment plane

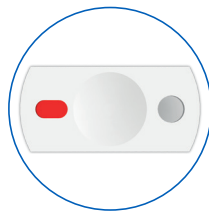
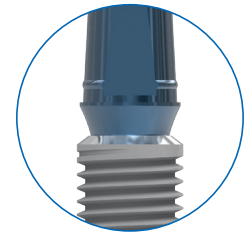

Fig. 2: Anti-rotational plane of the abutment signalling

Z2Plus® Mount uses

As a Mount



Implant view + Mount

As a transfer for Snap-On

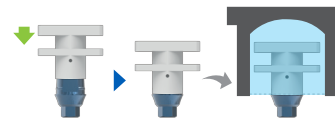

Implant view + Mount as a transfer for Snap-On

As straight abutment

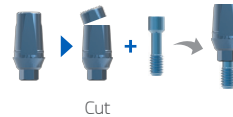

Z2Plus® option. References

	IMPLANT				PLATFORM			
	Ø (mm)	Ø Core (mm)	Length	REF.	Type	Ø (mm)	Internal metric	
Zinic®SHORTY	4,75	4,00	6,0 mm	ZSS4756HTN	● RP	3,50	M1,80	
			7,0 mm	ZSS4757HTN				
	5,25	4,50	6,0 mm	ZSS5256HTN	● RP	4,50	M1,80	
			7,0 mm	ZSS5257HTN				

(1) Depth of the internal hexagon. (2) Distance between internal hex faces. (3) Platform work diameter.

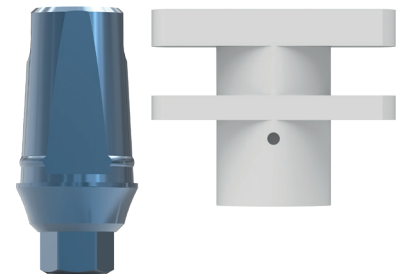

Z2Plus® as a transfer for Snap-On

Cover screw*



Platf.	Length (L)	Reference
●	4,20 mm	ZRPT
●	4,20 mm	ZWPT

Anodised ■ RP ■ WP



* Screw already included in each implant.

ZIACOM® No Mount

Packaging and product handling

1. Click on the word "PRESS" and rip the carton.

2. Remove the cardboard flap and take out the blister.

3. Carefully remove the blister seal from the implant.

4. Drop the vial on the sterile cloth in surgical area.

5. Hold the vial with one hand in a vertical position. Remove the cap by turning it vertically.

Implant removal

6. Hold the implant holder vial vertically with one hand and place, for ratchet or CA, insert into the Zinic® Shorty implant.

Ref. LMZ/SMZ/MMZ,
Ref. LMZI/SMZI/MMZI or
Ref. LMZ2/SMZ2/MMZ2

8. Remember to remove the label from the implant to paste it onto the patient's implantation document and thus maintain product traceability.

7. Remove the implant Zinic® Shorty assembly by pulling it up vertically to the vial.

Ref. LMZ/SMZ/MMZ,
Ref. LMZI/SMZI/MMZI or
Ref. LMZ2/SMZ2/MMZ2 + RATC50

Ref. LMZ/SMZ/MMZ,
Ref. LMZI/SMZI/MMZI or
Ref. LMZ2/SMZ2/MMZ2 + MADW10

Ref. LMZ/SMZ/MMZ,
Ref. LMZI/SMZI/MMZI or
Ref. LMZ2/SMZ2/MMZ2 + Contra-angle

ZIACOM® No Mount are packaged in a sealed carton box with a product label for immediate identification. It contains:

- **Instructions for Use (IFU).**
- **Implant blister:** heat-sealed, with product identification labels for correct traceability. Its flap facilitates opening in clinic and prevents accidental opening. Contains: implant carrier vial.
- **Implant carrier vial:** contains vertically suspended implant.
- **Product identification label data:** product reference, platform, implant diameter and length, product description, batch number, product manufacturer, expiration date and product identification symbols.

Note. Do not open the sterile container until the time of implant placement.

ZIACOM®
ZINIC® SHORTY
 4.75X6mm
 MD ZSS4756HTF
 LOT Z0000000
 1 Unid RP Ø4.75X6mm
 NoMount
 www.ziacom.es
 UDI
 (01)08435481257896(17)000000(11)000000(10)Z0000000
 UDI
 0000-00-00 0000-00-00
 Rx Only

Implante Dental	ES
Dental Implant	EN
Zahnimplantat	DE
Implant Dentaire	FR
Implanto Dentale	IT
Implante Dentário	PT

ZIACOM MEDICAL, S.L.U. P.I. nº 150
 ZIACOM MEDICAL USA, LLC
 353 S.E. 2nd Avenue, Suite 2000
 Miami, FL 33131 - USA
 Tel: +1 (786) 224-0089
 Fax: +1 (786) 224-3936

Description of the symbology used

- | | | | |
|---------|---|---------|--|
| CE | MDD CE certification and notified body | ☒ | Do not resterilise |
| MD | Name of the medical device | ☒ | Do not use if the packaging is damaged |
| LOT | Number of product batch | ☒ | Non-reusable product |
| 🌐 | Patient information website | 📖 | Consult the instructions for use |
| UDI | Unique device identification | 📅 | Expiry date of the product |
| STERILE | Beta sterile product | 🏭 | Date of manufacture |
| 🌡️ | Temperature restriction | 🏢 | Product manufacturer |
| ⚠️ | Caution, consult accompanying documents | Rx Only | Caution: federal law prohibits dispensing without prescription |

Features and references

ZIACOM® No Mount implant packaging option allows you to use an insertion key direct to implant, remove it from the implant carrier vial and bring it to your surgical site easily and safely.

No Mount system instruments:

- » **Zinic®** insertion key for contra-angle.
- » **Zinic®** insertion key for ratchet

ZIACOM® No Mount implant has the advantage of avoiding its handling to disassemble the Mount, removing the occasional difficulty of access to the location with reduced mouth opening or suppressing the risk of primary stability reduction due to over-instrumentation. The plastic vial holds the implant vertically between a lower titanium plate and an upper washer also made of titanium, providing stability without movement, while avoiding contact.

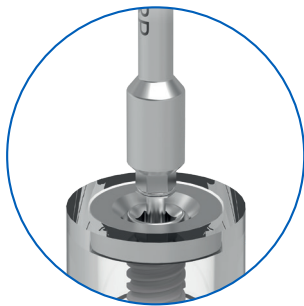

Zinic® insertion key connection view

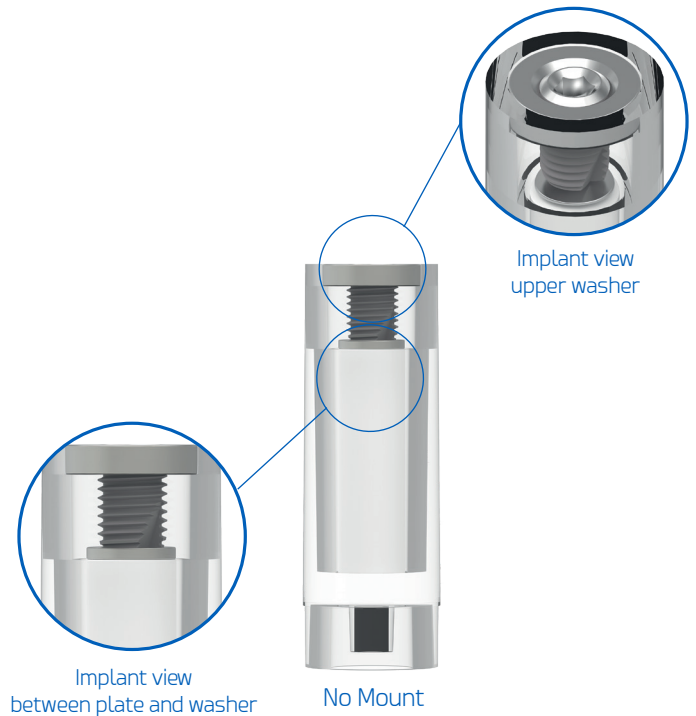

Implant view upper washer

Implant view between plate and washer

No Mount

ZIACOM® No Mount option. References

	IMPLANT				PLATFORM				
	Ø (mm)	Ø Core (mm)	Length	REF.	Type	Ø (mm)	Internal metric		
Zinic®SHORTY	4,75	4,00	6,0 mm	ZSS4756HTF	● RP	3,50	M1,80		
			7,0 mm	ZSS4757HTF					
Zinic®SHORTY	5,25	4,50	6,0 mm	ZSS5256HTF	● RP	4,50	M1,80		
			7,0 mm	ZSS5257HTF					

(1) Depth of the internal hexagon. (2) Distance between internal hex faces. (3) Platform work diameter.



* Cover screw:

In **ZIACOM® No Mount** option, cover screws are supplied separately (see the references on page 13).

Zinic[®]SHORTY

Surgical procedure

Important: Read carefully the recommendations of the surgical protocol and implant manipulation for predictable results.

Risk of not respecting the recommendations of the drilling sequence:

- Difficulty in implant insertion.
- Overcompression in the implant site.
- Reducing primary stability and make osseointegration impossible.



General considerations

ZIACOM® drills system

The drills of ZIACOM® implant systems are made of stainless steel.

The drills must be handled carefully, avoiding damage that could compromise their effectiveness. Make sure that the drills are in proper condition. If in doubt, avoid using it.

Indications for the drilling sequence

- The drills must be inserted at the contra-angle with the surgical motor stopped, ensuring correct anchorage and rotation before starting the drilling.
- The drills must be used with external irrigation.
- The recommended speed and torque for each drill must be respected. (See drilling sequence / Pages 26, 27 and 28).
- Position the drill at the location chosen for implant insertion before starting drilling.
- Perform controlled swinging movements, drilling the bone to the desired depth, guided by the laser reference mark of that depth.
- Remove the drill from the surgical site with the motor running.

Notes:

- Do not continue drilling without irrigation.
- If using a drill extender, supplement irrigation manually.
- For surgical and cortical drills, a maximum of 45 uses per drill is recommended. Exceeding the recommended use endangers the osseointegration process of the implant.
- If you notice any damage to the drill, avoid using it and replace it with a new one.
- After each use, sterilise them according to the cleaning and sterilisation instructions (Page 30).

Surgical drills

ZIACOM® surgical drill length measuring system is simple and guides you through the surgical site drilling process. The laser marking on the shaft of the drills identifies their diameter and the horizontal band of the laser marking on its active part represents the different lengths of the implants (millimeter drills).

When performing implant placement without flap lifting, measure the thickness of the soft tissue with a periodontal probe and add this measurement to the drilling depth.

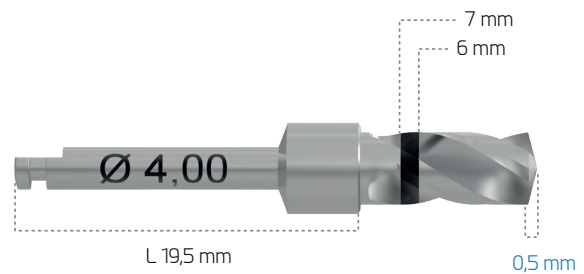

Surgical taps

The use of surgical tap for thread-forming in each implant diameter depends on the diameter and type of bone. (See drilling sequence / Step 9 / Page 19).

Contra-angle taps are available.

The laser marking on the shaft of the taps identifies their diameter and the horizontal band of the laser marking on its active part represents the different lengths of the implants.

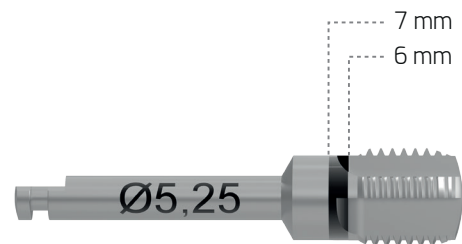

Depth gauge

This instrument has an horizontal laser marking band in its active part that represent the different lengths of the implants. It can be used to verify the depth of the surgical site prior to implant insertion. It has a hole in the handle to secure the instrument with dental floss or suture to prevent complications during the surgical procedure.

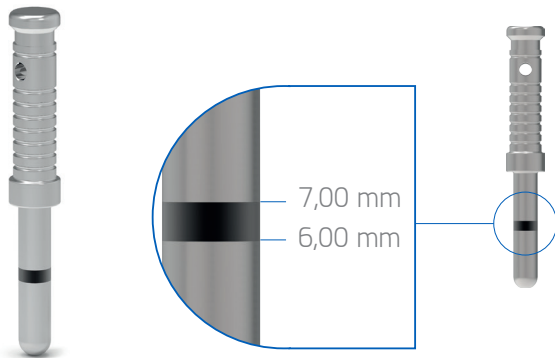

Drill stops

The ZIACOM® drill stops system has been created to simplify the drilling sequence, ensuring depth control of the osteotomy. The stops have a laser mark that represents the length corresponding to the implant to be placed, and therefore the depth of the drill.



WARNING: When using a drill with stop, the length of the drill tip must be taken into consideration, as the stops are calibrated to the actual length of the laser marks, not counting the length of the drill tip.

The drill stops use a friction locking system. To assemble, insert the stop through its grooved area over the tip of the drill and push it back until it rubs against the drill as shown in the drawing below. The laser marking line of the drill and the stop must coincide with the selected length.

Double paralleling pin

Paralleling pins are instruments to indicate the surgical site direction to the clinician during drilling. It has two active parts of 2,50 and 3,00mm respectively. It has a hole in the middle area to secure the instrument with dental floss or suture to prevent complications during the surgical procedure.

It has laser marking that identifies the diameters of the active tips. The smallest and largest diameter can be easily identified, with one and two grooves respectively.



Zinic®Shorty SURGICAL PROCEDURE MANUAL

Steps for placing Zinic®Shorty implants		Instruments required	Implant insertion
ZPlus® Mount option	Z2Plus® Mount option	No Mount option	Soft tissue conditioning

Steps for placing Zinic®Shorty implants

Instruments required



Zinic®Shorty

• **EXAMPLE:**
Zinic®Shorty implant
Ø4,75x6,00mm

● **RP (Ø4,00mm)**
Ø platform 4,75mm

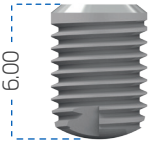

Step 02

Pilot drill Ø2,50



Continue the drilling sequence with the pilot drill Ref- OTD25HT until the total length corresponding to the selected implant is reached. Be attentive to the laser mark on the drill that gives the length or you can use the drill stop Ref-ZSS06HT. Check the direction and inclination of the drill, always making intermittent pressure in a vertical direction, taking care not to generate excessive pressure on the bone. If necessary, use the drill extender Ref-DEXT10.



Preliminary step

Gingiva opening

Make an incision and flap reflection.

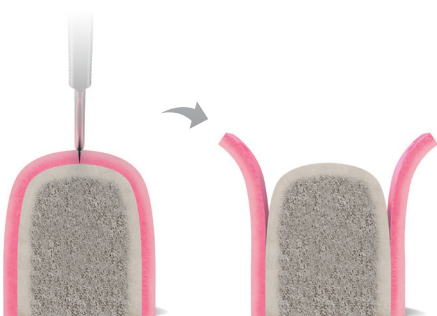

Step 03

Double paralleling pin Ø2,50/3,00



Check the parallelism between implants or between implant and teeth with the Ref- PARA50 double paralleling pin. You can repeat this step as many times as you consider necessary throughout the surgical procedure.

Step 01

Lance drill



Start surgical site drilling sequence using the lance drill Ref- EXSID00 to its stop (length 5,0mm). Check the direction and inclination of the drill, always making intermittent pressure in a vertical direction, taking care not to generate excessive pressure on the bone. If necessary, use the drill extender Ref-DEXT10.



Step 04

Surgical drill Ø3,00



Continue the drilling sequence with the Ref- OTD30HT Ø3,0 surgical drill until the total length corresponding to the selected implant is reached. Be attentive to the laser mark on the drill that gives the length or you can use the drill stop Ref-ZSS06HT. Check the direction and inclination of the drill, always making intermittent pressure in a vertical direction, taking care not to generate excessive pressure on the bone. If necessary, use the drill extender Ref-DEXT10.



Steps for placing Zinic®Shorty implants		Instruments required	Implant insertion
ZPlus® Mount option	Z2Plus® Mount option	No Mount option	Soft tissue conditioning

Step 05

Depth gauge



Check surgical site depth by inserting the depth gauge Ref-MURE30.

You can repeat this step as many times as you consider necessary throughout the surgical procedure.

Step 08



Tap



Place the surgical tap Ø4,75 on the surgical site. Press firmly and start turning slowly, then let the tap advance without pressure to the desired depth. If you encounter excessive resistance, make a 90° counter-rotation movement for each complete turn. To remove the tap, turn it in the opposite direction to the insertion one.

The tap should be used with contra-angle REF. ZTAP475HTM.

The use of the tap will depend on the type of bone:

		Type I	Total
		Type II	2/3
		Type III-IV	Not necessary

Step 06

Surgical drill Ø3,50



Continue the drilling sequence with the Ref- OTD35HT Ø3,50 surgical drill until the total length corresponding to the selected implant is reached. Be attentive to the laser mark on the drill that gives the length or you can use the drill stop Ref-ZSS06HT. Check the direction and inclination of the drill, always making intermittent pressure in a vertical direction, taking care not to generate excessive pressure on the bone. If necessary, use the drill extender Ref-DEXT10.



Step 07

Surgical drill Ø4,00



Continue the drilling sequence with the surgical drill Ø 4,00 Ref- OTD40HT, until the total length corresponding to the selected implant is reached. Be attentive to the laser mark on the drill that gives the length or you can use the drill stop Ref-ZSS06HT. Check the direction and inclination of the drill, always making intermittent pressure in a vertical direction, taking care not to generate excessive pressure on the bone. If necessary, use the drill extender Ref-DEXT10.



Zinic®Shorty SURGICAL PROCEDURE MANUAL

Steps for placing Zinic®Shorty implants		Instruments required	Implant insertion
ZPlus® Mount option	Z2Plus® Mount option	No Mount option	Soft tissue conditioning

Implant insertion

ZPlus® Mount option

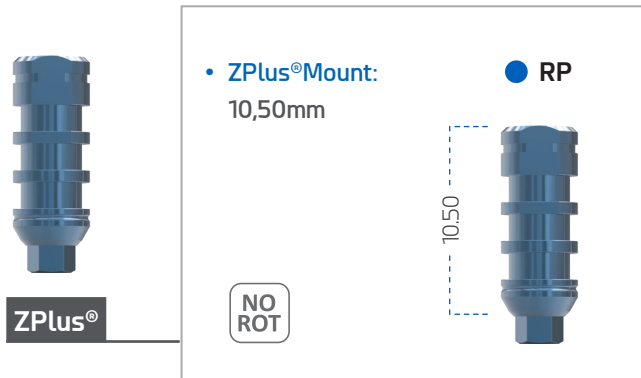

Step 02

Choice of insertion instrument

Depending on the clinical situation and access to the area, three different instruments can be chosen to insert the implant:

- A Contra-angle.** Use ZPlus® insertion key. CA of the length of your choice (Ref.01MMIN or 02MMIN) and insert it into the contra-angle
- B Ratchet Ref. RATC50:** Use ZPlus® insertion key. Ratchet/Manual of the length of your choice (Ref. XSMIN, TSMIN or TLMIN) and insert it into the ratchet in function "IN".
- C Screwdriver handle 4x4 Ref. MADW10.** Use ZPlus® insertion key. Ratchet/Manual of the length of your choice (Ref. XSMIN, TSMIN or TLMIN) and insert it into the screwdriver handle.

Step 01

Implant unpacking

- 1.1 Click on the word "PRESS" and rip the implant carton box.
- 1.2 Remove the flap from the carton and pull out the blister.
- 1.3 Carefully remove the blister seal.
- 1.4 Drop the implant vial onto a sterile cloth in the surgical area.
- 1.5 Remember to remove the label from the implant to paste it onto the patient's passport and thus maintain product traceability.

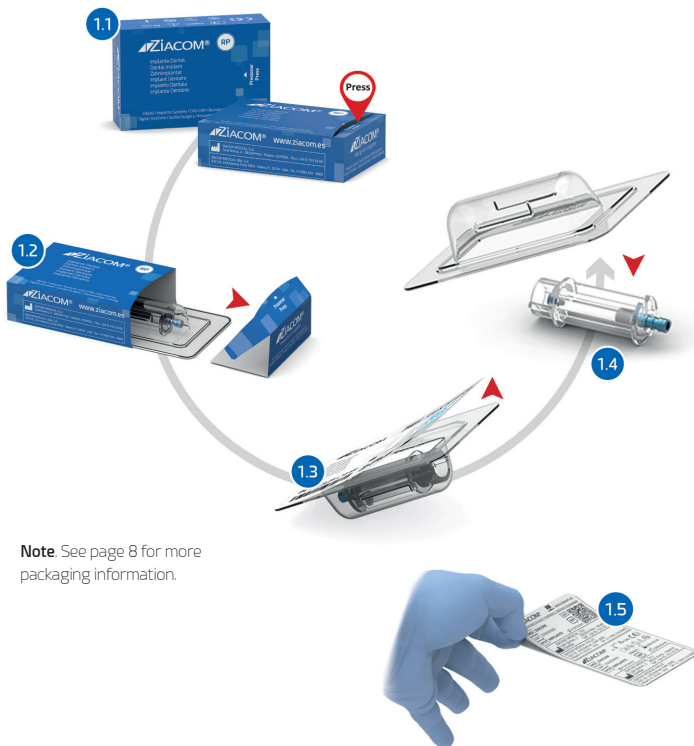

Note. See page 8 for more packaging information.

Step 03

Remove the implant from the vial

Hold the implant carrier vial in one hand and insert the selected insertion key into the ZPlus® with the other hand. Remove the implant-mount assembly by pulling up the vial vertically.

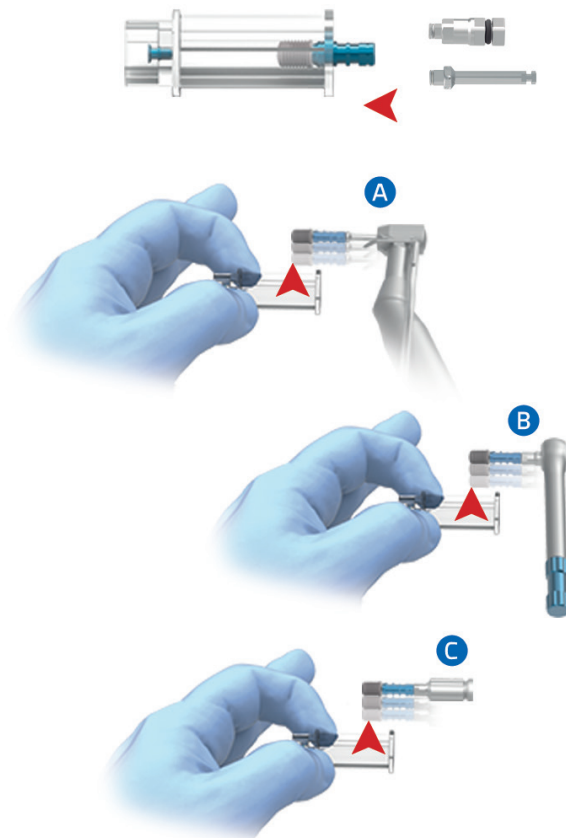

Steps for placing Zinic®Shorty implants		Instruments required	Implant insertion
ZPlus® Mount option	Z2Plus® Mount option	No Mount option	Soft tissue conditioning

Step 04

Implant insertion

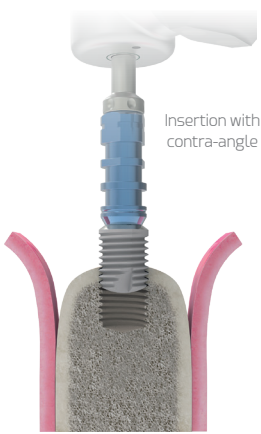

Insertion with contra-angle

Insert the implant into the surgical site, controlling the direction and inclination.

When inserting with contra-angle, use a maximum speed of 25 Rpm.

The recommended insertion torque is between 35 and 50 Ncm depending on each case, without being limited to a single torque.

If there is resistance during insertion, it is recommended that the implant be rotated in the opposite direction to the insertion direction and after seconds of pause continue with insertion. Repeat this process as many times as necessary.

ZPlus® has three flat faces. At the end of the implant insertion, make sure that one of them matches the vestibular area.

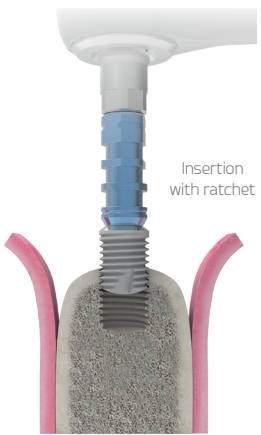

Insertion with ratchet

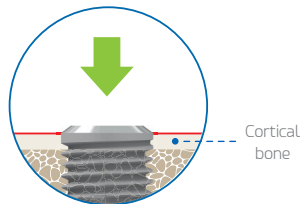

Cortical bone

The ZIACOM® surgical protocol establishes crestal position of the implant platform.

Step 05

ZPlus® Mount disassembly

Lock the ZPlus® Mount with the block key Ref. 01MOHW and remove the screw with the manual surgical screwdriver Ref. SMSD or LMSD. After removing the screw, pull out the ZPlus® manually.

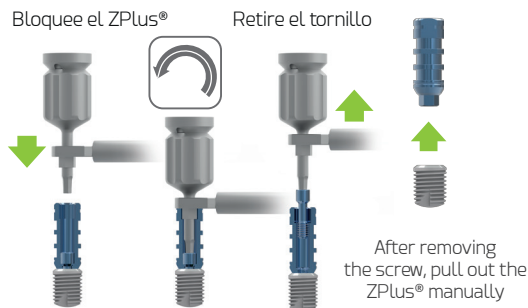

Step 05-A

ZPlus® Mount disassembly

To avoid ZPlus® Mount deformation or cold welding with the implant, the insertion point at which it should be disassembled will depend on the type of bone.

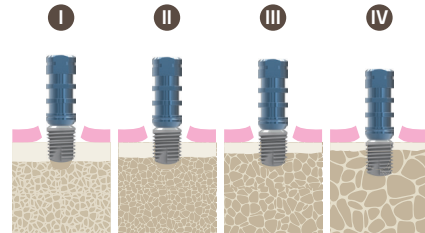

Type I	A 1/2 of placement
Type II	A 3/4 of placement
Type III	A 4/5 of placement
Type IV	Full placement

Step 05-B

ZPlus® Mount disassembly

In case of cold seizure or cold welding of ZPlus® on the implant after insertion : avoid manipulating the mount with instruments in a way that can reduce primary stability. Only use the ZIACOM® extractor screw Ref. and EDSZ34 (RP/WP).

By inserting the extractor screw with a manual surgical screwdriver Ref. SMSD or LMSD and manual torque, in a clockwise direction, the apex contacts the implant, unlocking the mount and releasing it for removal.

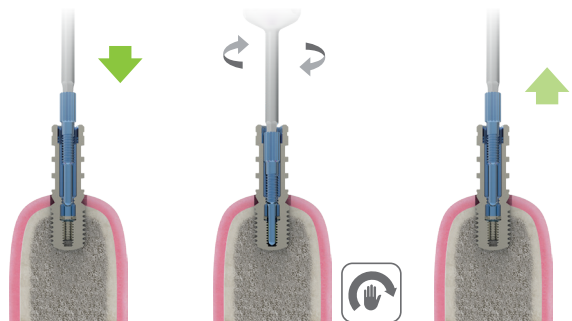

Step 1

Step 2

Step 3

Once the clinical screw is removed, insert the extractor screw

Turn the screwdriver clockwise until it contacts the implant, turn an additional quarter turn to unlock

Once the Mount has been released, remove the screw extractor.



Steps for placing Zinic®Shorty implants		Instruments required	Implant insertion
Z2Plus® Mount option	Z2Plus® Mount option	No Mount option	Soft tissue conditioning

Implant insertion

Z2Plus® Mount option

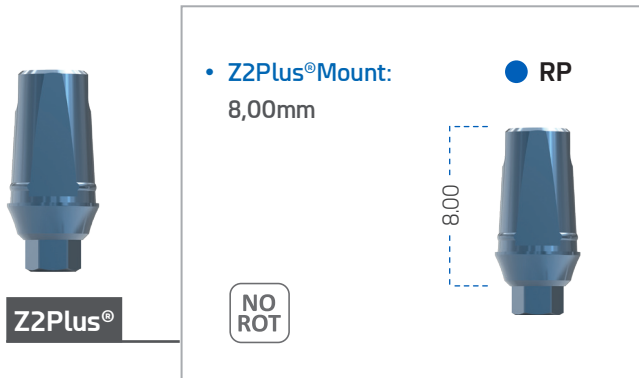

Step 02

Choice of insertion instrument

Depending on the clinical situation and access to the area, three different instruments can be chosen to insert the implant:

- A Contra-angle.** Use Z2Plus® insertion key. CA of the length of your choice (Ref.01MMIN or 02MMIN) and insert it into the contra-angle
- B Ratchet Ref. RATC50:** Use Z2Plus® insertion key. Ratchet/Manual of the length of your choice (Ref. XSMIN, TSMIN or TLMIN) and insert it into the ratchet in function "IN".
- C Screwdriver handle 4x4 Ref. MADW10.** Use Z2Plus® insertion key. Ratchet/Manual of the length of your choice (Ref. XSMIN, TSMIN or TLMIN) and insert it into the screwdriver handle.

Step 01

Implant unpacking

- 1.1 Click on the word "PRESS" and rip the implant carton box.
- 1.2 Remove the flap from the carton and pull out the blister.
- 1.3 Carefully remove the blister seal.
- 1.4 Drop the implant vial onto a sterile cloth in the surgical area.
- 1.5 Hold the vial with one hand in a vertical position. Remove the cap by turning it vertically.
- 1.6 Remember to remove the label from the implant to paste it onto the patient's passport and thus maintain product traceability.

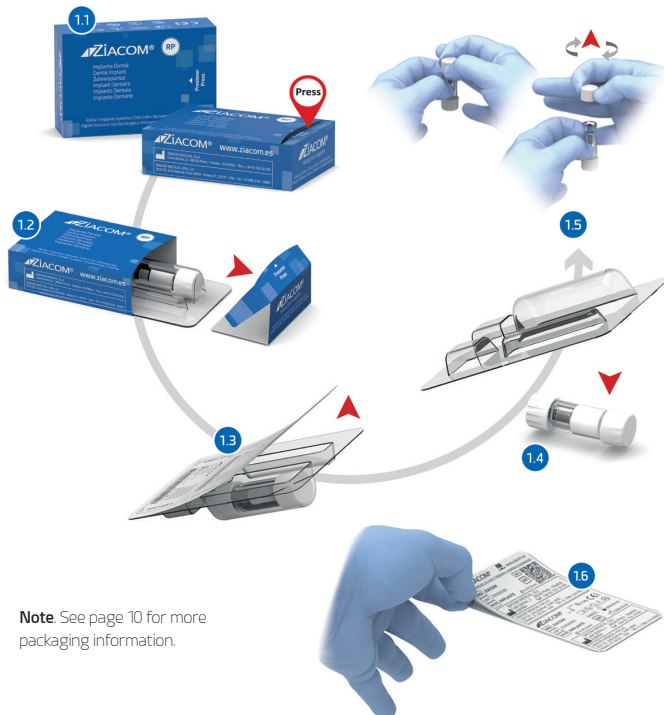

Step 03

Remove the implant from the vial

Hold the implant carrier vial in one hand and insert the selected insertion instrument into Z2Plus® with the other hand. Remove the implant-mount assembly by pulling up the vial vertically.

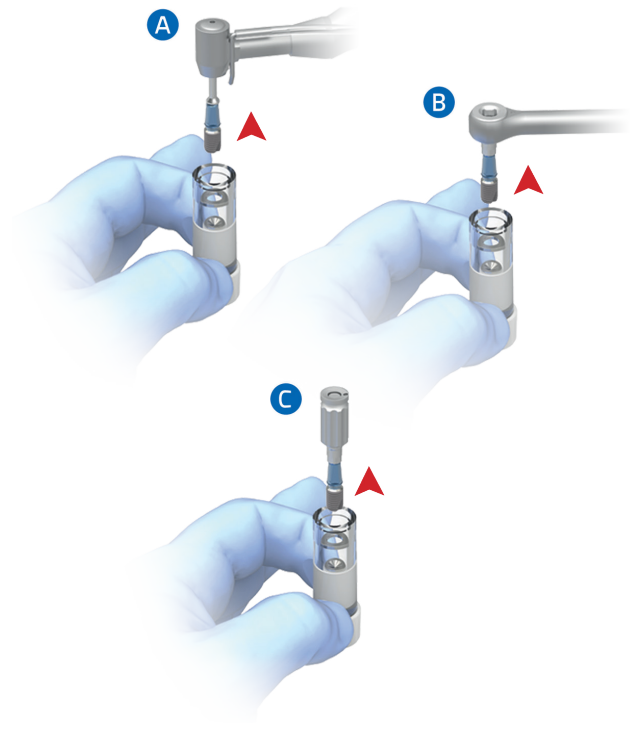

Steps for placing Zinic®Shorty implants		Instruments required	Implant insertion
ZPlus® Mount option	Z2Plus® Mount option	No Mount option	Soft tissue conditioning

Step 04

Implant insertion

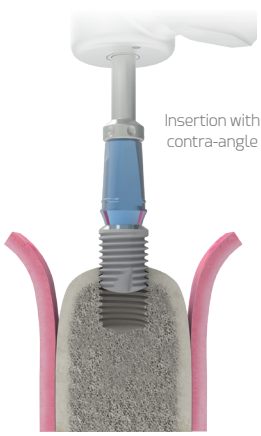

Insertion with contra-angle

Insert the implant into the surgical site, controlling the direction and inclination.

When inserting with contra-angle, use a maximum speed of 25 Rpm.

The recommended insertion torque is between 35 and 50 Ncm depending on each case, without being limited to a single torque.

If there is resistance during insertion, it is recommended that the implant be rotated in the opposite direction to the insertion direction and after seconds of pause continue with insertion. Repeat this process as many times as necessary.

Z2Plus® has a flat face. At the end of the implant insertion, make sure that the flat face matches the vestibular area.

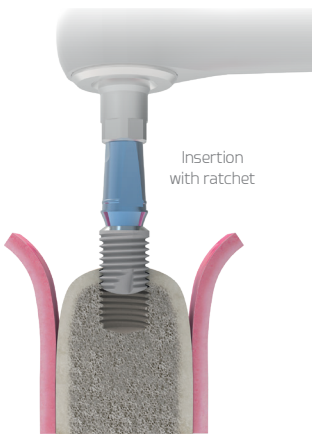

Insertion with ratchet

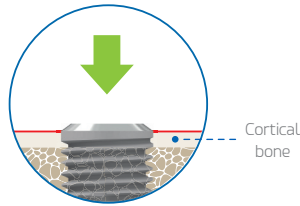

Cortical bone

The ZIACOM® surgical protocol establishes crestal position of the implant platform.

Step 05

Z2Plus® Mount disassembly

Lock Z2Plus® Mount with the block key Ref. 01M0HW and remove the screw with the manual surgical screwdriver Ref. SMSD or LMSD. After removing the screw, pull out Z2Plus® manually.

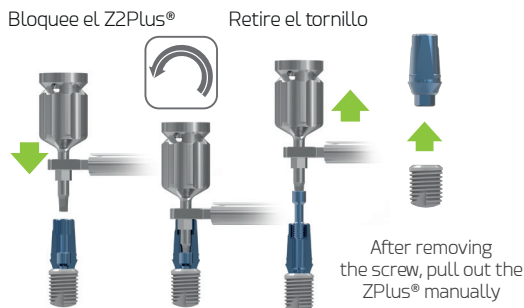

Step 05-A

Z2Plus® Mount disassembly

To avoid Z2Plus® Mount deformation or cold welding with the implant, the insertion point at which it should be disassembled will depend on the type of bone.

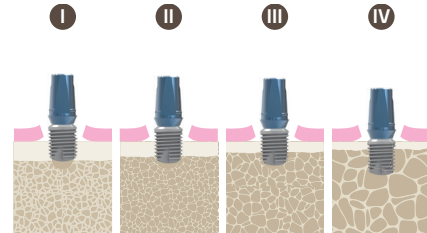

Type I	A 1/2 of placement
Type II	A 3/4 of placement
Type III	A 4/5 of placement
Type IV	Full placement

Step 05-B

Z2Plus® Mount disassembly

In case of cold seizure or cold welding of Z2Plus® on the implant after insertion: avoid manipulating the mount with instruments in a way that can reduce primary stability. Only use the ZIACOM® extractor screw Ref. and EDSZ34 (RP/WP).

By inserting the extractor screw with a manual surgical screwdriver Ref. SMSD or LMSD and manual torque, in a clockwise direction, the apex contacts the implant, unlocking the mount and releasing it for removal.

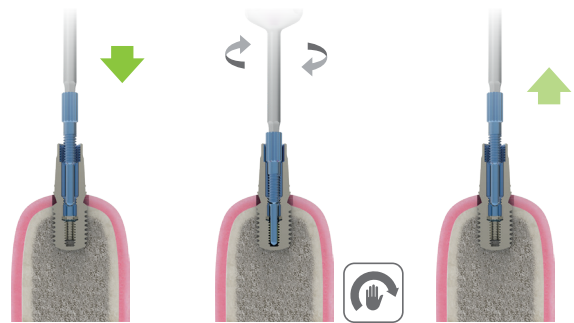

Step 1

Step 2

Step 3

Once the clinical screw is removed, insert the extractor screw

Turn the screwdriver clockwise until it contacts the implant, turn an additional quarter turn to unlock

Once the Mount has been released, remove the screw extractor.



Zinic®Shorty SURGICAL PROCEDURE MANUAL

Steps for placing Zinic®Shorty implants		Instruments required	Implant insertion
ZPlus® Mount option	Z2Plus® Mount option	No Mount option	Soft tissue conditioning

Implant insertion

ZIACOM® No Mount option

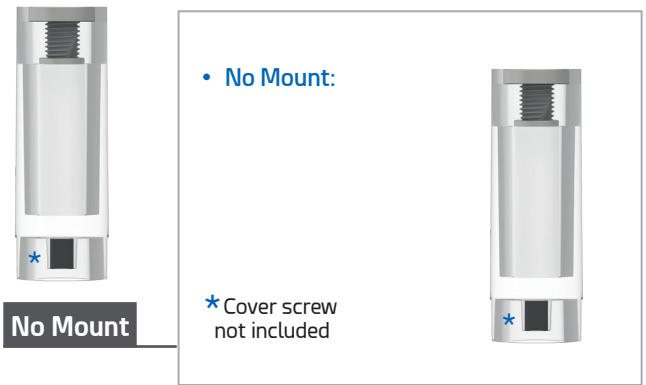

Step 01

Implant unpacking

- 11 Click on the word "PRESS" and rip the implant carton box.
- 12 Remove the flap from the carton and pull out the blister.
- 13 Carefully remove the blister seal.
- 14 Drop the implant vial onto a sterile cloth in the surgical area.
- 15 Hold the vial with one hand in a vertical position. Remove the cap by turning it vertically.
- 16 Remember to remove the label from the implant to paste it onto the patient's passport and thus maintain product traceability.

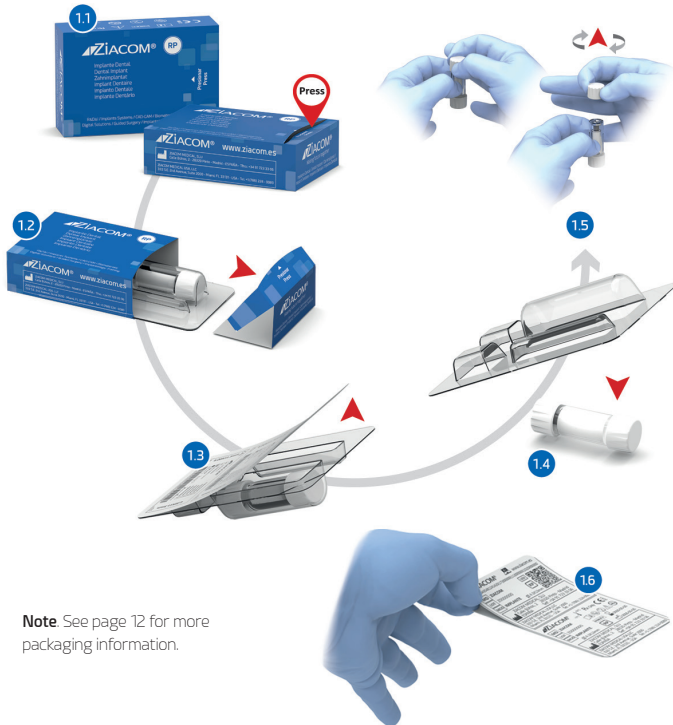

Step 02

Choice of insertion instrument

Depending on the clinical situation and access to the area, three different instruments can be chosen to insert the implant:

- A Contra-angle.** Use Zinic® insertion key. CA Ref. MMZI and insert it into the contra-angle.
- B Ratchet Ref. RATC50:** Use Zinic® insertion key. Ratchet/Manual of the length of your choice (Ref. SMZI or LMZI) and insert it into the ratchet in function "IN".
- C Screwdriver handle 4x4 Ref. MADW10.** Use Zinic® insertion key. Ratchet/Manual of the length of your choice (Ref. SMZI or LMZI) and insert it into the screwdriver handle.

Step 03

Remove the implant from the vial

Hold the implant carrier vial in one hand and insert the selected insertion key into the implant with the other hand. Remove the implant by pulling up the vial vertically.

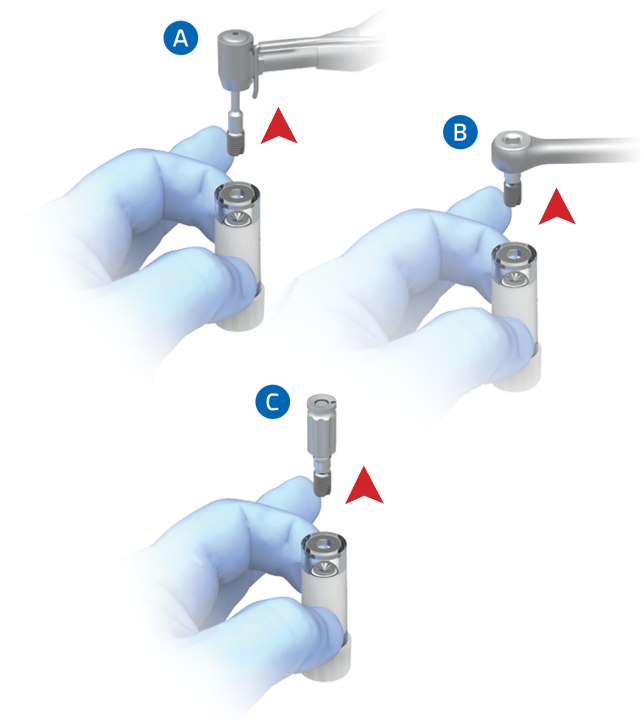

Steps for placing Zinic®Shorty implants		Instruments required	Implant insertion
ZPlus® Mount option	Z2Plus® Mount option	No Mount option	Soft tissue conditioning

Step 04
Implant insertion



Insertion with contra-angle

When inserting with contra-angle, use a maximum speed of 25 Rpm.

The recommended insertion torque is between 35 and 50 Ncm.

If there is resistance during insertion, it is recommended that the implant be rotated in the opposite direction to the insertion direction and after seconds of pause continue with insertion. Repeat this process as many times as necessary.

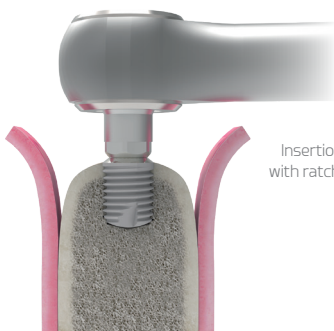

Insertion with ratchet

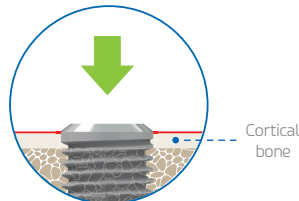

Cortical bone

The ZIACOM® surgical protocol establishes crestal position of the implant platform.

Soft tissue conditioning

Step 01

Cover screw placement

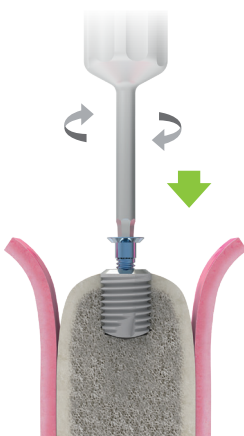

Depending on the package, remove the cover screw from the vial with the manual surgical screwdriver Ref. SMSD or LMSD, counterclockwise.

Approach it to the implant avoiding the fall and accidental screw swallowing. Insert it into the implant until it locks, with manual torque and clockwise.

In ZIACOM® No Mount option, the cover screws are supplied separately.

Cover screw placement requires a second surgery for implant uncovering and desired abutment placement.

Depending on the case, you can choose not to place a cover screw but to place a healing abutment directly.



Step 02
Soft tissue closure



Close and suture the soft tissue, fitting the flaps carefully.

Step 03
Uncovering and removing the cover screw

Locate the implant and make an incision until the cover screw is exposed or use the tissue punch Ref. MPU34 on the soft tissue. Remove the screw with the manual surgical screwdriver Ref. SMSD or LMSD.



Step 04

Healing abutment placement

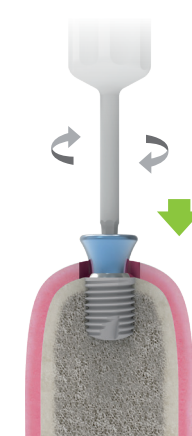

Insert the selected healing abutment with the manual surgical screwdriver Ref. SMSD or LMSD.

The choice of the healing abutment will depend on each case. It must match the implant platform and be in accordance with the height of the gingival tissue to avoid abutment occlusion. Excessive height could subject the implant to premature loading, compromising the osseointegration process.



ZINIC[®]SHORTY

Surgical drilling protocol with ZPlus[®] Mount

Rotation Irrigation required Drill diameter See instructions Torque

Detailed speeds are the recommended

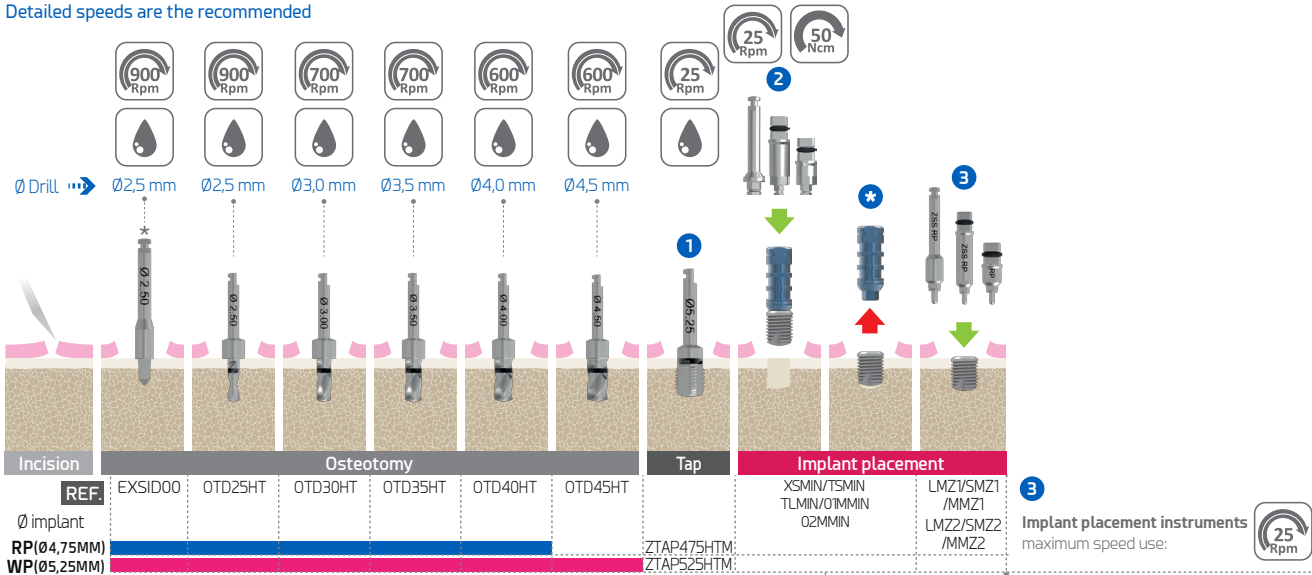

* Increase 200 Rpm for drilling in bone Type I/Type II according to the above graphic.
UNDERSIZED DRILLING: to be assessed on Type III and IV bones
IMPORTANT: control the drilling axis by applying intermittent pressure (tapping) always in the vertical plane, taking care not to exert excessive pressure on the bone.

* Mount Disassembly

Insertion point in which to disassemble it according to the type of bone

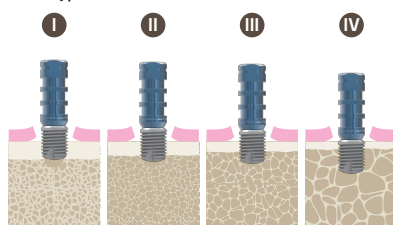

Remove Zinic[®]Shorty implant from the carrier bar contained in the blister and then put it in the surgical bed with insertion key adapted to the ZPlus[®] Mount (due to its narrow length). This allows to achieve enough mechanical anchoring to proceed to its removal afterwards.

Lock the Mount with the ZPlus[®] block key ref: 01MOHW and remove the screw with the screwdriver ref: SMSD/LMSD. After that, you can remove the implant. (For type I and II bones, you do not must make the complete implant insertion with the ZPlus[®] Mount).

Once the Mount has been removed, use the insertion keys for ratchet or contra-angle until the implant platform had been placed in the position indicated in the protocol.

Removing the screw

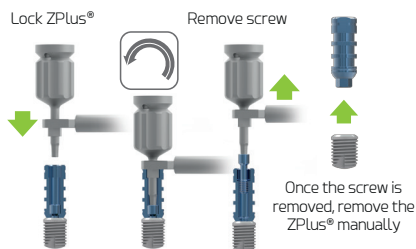

REF: SMSD/LMSD with 01MOHW

Important: in case the ZPlus[®] is retained with the implant, use the extractor screw to facilitate its extraction: with RP and WP platforms, ref: EDSZ34

ZPlus[®]/Z2Plus[®] Mount recommendation

In case of cold seizure or cold sealing of ZPlus[®]/Z2Plus[®] after its insertion in the implant: avoid manipulating the screwdriver with instruments in a way that can reduce primary stability. Only use the ZIACOM[®] extractor screw Ref. EDSZ34 (RP/WP). When the extractor screw (with screwdriver 125 mm and manual torque) is inserted clockwise, an expected contact occurs from its apex with the implant, unlocking the Mount and releasing it for removal.



TAP

1 INSERTION AND REMOVAL OF THE MOUNT
Very important: consult the warnings about insertion and torque.

1 Tap usage
 Depending on bone type:



Contra-angle (CA)

Type	Total
Type I	Total
Type II	2/3
Type III-IV	Not necessary

The maximum speed limit must be taken into account.

2

Tubes usage

For those cases of reduced vertical dimension, either because of limited oral opening of the patient or extrusion of antagonist pieces, use a shorter instrument than the Mount plus a insertion key: in the Zinic[®]Shorty surgical boxes are 2 tubes included of Ø4,75 and Ø5,25 where implants should be deposited. Disassemble the ZPlus[®]/Z2Plus[®] before taking them into their beds using Zinic[®] insertion key direct to implant.

Insertion key with ref:
 - SMZ1/SMZ2 for ratchet/manual
 - MMZ1/MMZ2 for contra-angle



Implant placement at crestal level

ZIACOM[®] implant platforms should be placed at bone crest level.

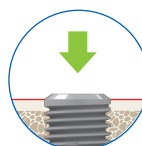

ZINIC[®]SHORTY

Surgical drilling protocol with Z2Plus[®] Mount

Rotation Irrigation required Drill diameter See instructions Torque

Detailed speeds are the recommended

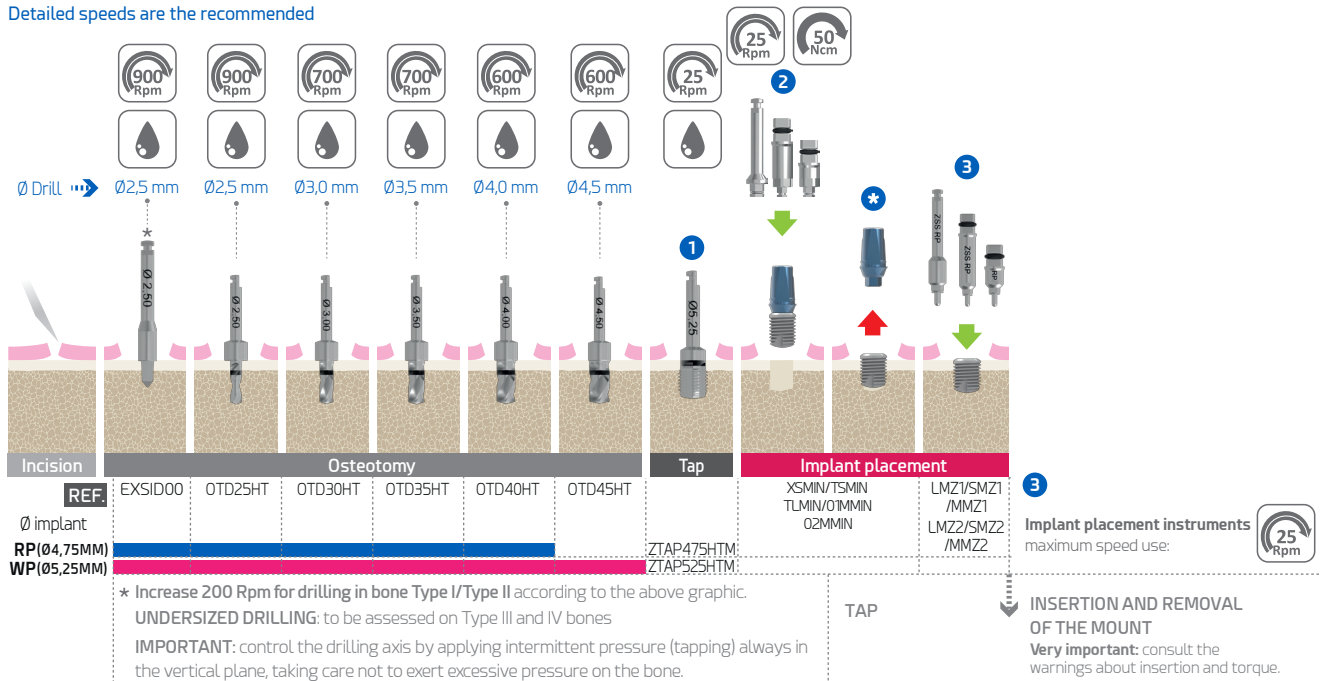

* Mount Disassembly

Insertion point in which to disassemble it according to the type of bone

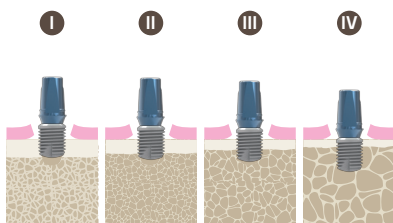

Remove Zinic[®]Shorty implant from the carrier bar contained in the blister and then put it in the surgical bed with insertion key adapted to the Z2Plus[®] Mount (due to its narrow length). This allows to achieve enough mechanical anchoring to proceed to its removal afterwards.

Lock the Mount with the Z2Plus[®] block key ref: 01M0HW and remove the screw with the screwdriver ref: SMSD/LMSD. After that, you can remove the implant. (For type I and II bones, you do not must make the complete implant insertion with the Z2Plus[®] Mount).

Once the Mount has been removed, use the insertion keys for ratchet or contra-angle until the implant platform had been placed in the position indicated in the protocol.

Removing the screw

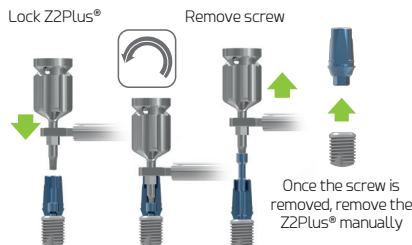

REF.: SMSD/LMSD with 01M0HW

Important: in case the Z2Plus[®] is retained with the implant, use the extractor screw to facilitate its extraction: with RP and WP platforms, ref: EDSZ34

Tap usage

Depending on bone type:



Contra-angle (CA)

Type	Total
Type I	Total
Type II	2/3
Type III-IV	Not necessary

The maximum speed limit must be taken into account.

2

Tubes usage

For those cases of reduced vertical dimension, either because of limited oral opening of the patient or extrusion of antagonist pieces, use a shorter instrument than the Mount plus an insertion key: in the Zinic[®]Shorty surgical boxes are 2 tubes included of ∅4,75 and ∅5,25 where implants should be deposited. Disassemble the ZPlus[®]/Z2Plus[®] before taking them into their beds using Zinic[®] insertion key direct to implant.

Insertion key with ref:
 - SMZ1/SMZ2 for ratchet/manual
 - MMZ1/MMZ2 for contra-angle

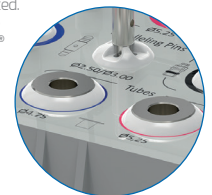

ZPlus[®]/Z2Plus[®] Mount recommendation

In case of cold seizure or cold sealing of ZPlus[®]/Z2Plus[®] after its insertion in the implant: avoid manipulating the Mount with instruments in a way that can reduce primary stability. Only use the ZIACOM[®] extractor screw Ref. EDSZ34 (RP/WP). When the extractor screw (with screwdriver 125 mm and manual torque) is inserted clockwise, an expected contact occurs from its apex with the implant, unlocking the Mount and releasing it for removal.



Implant placement at crestal level

ZIACOM[®] implant platforms should be placed at bone crest level.

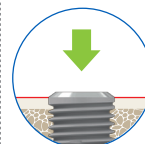

Surgical drilling protocol with ZIACOM[®] No Mount

Rotation Irrigation required Drill diameter See instructions Torque

Detailed speeds are the recommended

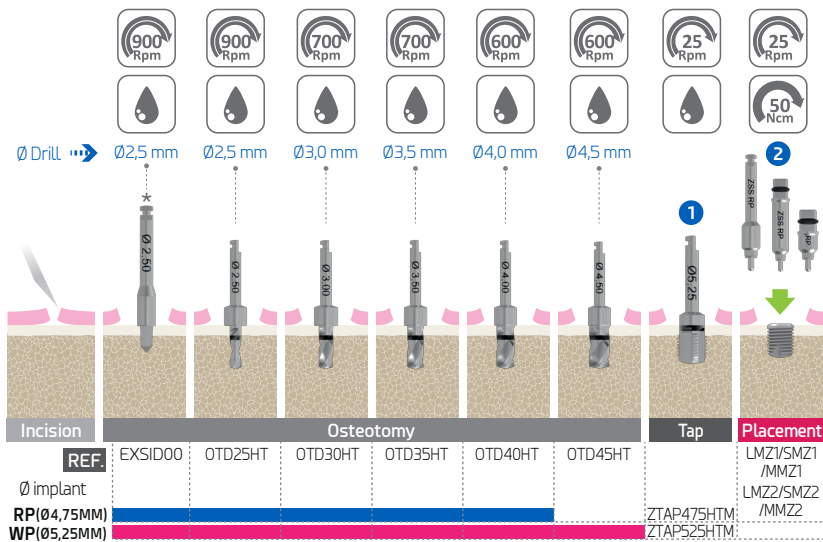

* Increase 200 Rpm for drilling in bone Type I/Type II according to the above graphic.
UNDERSIZED DRILLING: to be assessed on Type III and IV bones
IMPORTANT: control the drilling axis by applying intermittent pressure (tapping) always in the vertical plane, taking care not to exert excessive pressure on the bone.

2 Implant placement instruments
 maximum speed use:

TAP

1 Tap usage

Depending on bone type:

Contra-angle (CA)	
Type I	Total
Type II	2/3
Type III-IV	Not necessary

The maximum speed limit must be taken into account.

About ZIACOM[®] No Mount

ZIACOM[®] implants are available without Mount. This blister pack format allows dentists to comfortably remove the implant from the vial and place it in the surgical site with a direct instrument in a single step, saving time during the operation. The implantation without Mount facilitates instrumentation in reduced spaces and allows for better visibility of the surgical site. (See the steps on page 16 of this catalogue.)

The new Zinic[®] insertion keys direct to the implant, Ref. **LMZ1/SMZ1/MMZ1 (RP)** and **LMZ2/SMZ2/MMZ2/MMZ2 (WP)** have a centring device on their clamping part to avoid damaging the connection and a washer on the active end that provide a quick and safe function of transporting the implant to surgical site.



Implant placement at crestal level

ZIACOM[®] implant platforms should be placed at bone crest level.

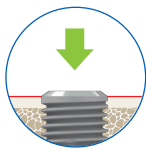

Treatment Planning

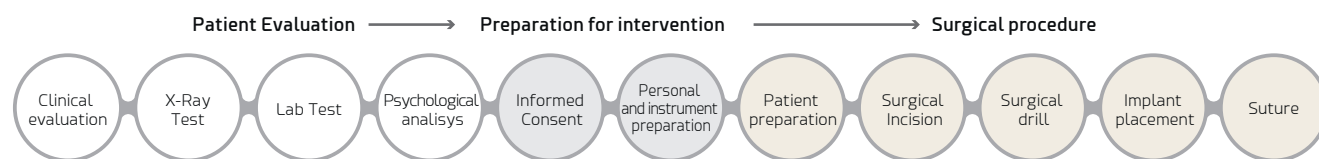

IMPORTANT WARNINGS

Speed use for contra-angle

Rpm maximum recommended must be respected. Screwdrivers and insertion keys for contra-angle: maximum 25 Rpm.



Insertion torque:

The Implant placement should be performed with controlled torque and according to the density and bone quality of the receptor bed.



The recommended insertion torque is between 35 and 50 Ncm according to each case without being limited to a single torque.

You can consult the bibliography at the end of this catalogue.

To avoid the cortical stress and deformation of the key and implant connection:

In order to avoid cortical stress and deformation of the key and/or implant connection, as well as Mount seizure, during insertion :

with contra-angle (CA) the recommended maximum speed (25 Rpm) and maximum torque (50 Ncm) must be respected.



For ratchet use, it is necessary to monitor the resistance that may cause an excessive compression in the bone. In case of perceiving this, it is recommended to remove the implant twice (to release the bone from the tension) and, after a few seconds, you may keep following with the insertion and make the process again as many times as necessary.

Failure to follow these warnings could result in:

- Irreversible distortions with the Mount.
- Disassembling Mount difficulties.
- Irreversible distortions in the internal and external connection of the implant.
- Disassembling in the implant/instrument difficulties.
- Implant insertion difficulties.
- Lack of primary stability due to loss bone.
- No osseointegration necrosis of bone due to excessive compression of the receptor bone.

Supplementary instrument

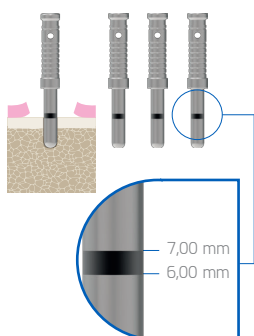

Depth gauge

Check the surgical site depth, especially if stoppers were not used.

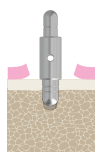

Paraleling pin

To check the surgical site axis, the paralleling pins have different diameters according to the drilling sequence.

Consider during intervention



Surgical drills should be inserted in the contra-angle with the surgical motor stopped, ensuring correct anchoring and rotation before starting drilling. Treat the drills with great care: the slightest damage to the tips can compromise their effectiveness.



Each instrument must be used only for the specific use recommended by the manufacturer.



Damaged instruments must be disposed according to the regulations established by the manufacturer.



The clinician must keep in the patient's file the identification label supplied with the product, for proper traceability.

Cover screw handling



Remove the cover screw from its vial using the hexagonal screwdriver anti-clockwise. Approach the implant avoiding the fall and accidental ingestion of the screw. Insert it into the implant until it closes, with manual torque and clockwise.

Second phase surgical procedure

Healing abutment placement

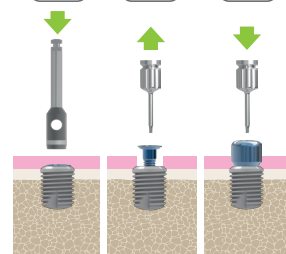

The healing abutment should correspond to the implant platform, considering the option of applying the platform switch technique with anatomical abutments and be in accordance with the height of the gingival tissue to avoid abutment occlusion. Excessive height could expose the implant to premature loading, compromising the osseointegration process.

Instructions for cleaning and disinfection of: instruments and boxes (surgical and prosthetic)

Protocol to be carried out by qualified personnel for the preparation of instruments and surgical/prosthetic boxes for use.

ATTENTION: the instruments and surgical/prosthetic boxes must be cleaned and disinfected after each use and sterilised before their next use. Pay attention to sharp elements, the use of gloves is recommended to avoid accidents during handling when following these instructions. Do not clean or disinfect instruments of different materials together.

Cleaning and disinfection of instruments

1- Disassembly

- Disassemble the instruments that require it such as manual ratchets (see diagram below), drills and drill stops.
- Disassemble the surgical/prosthetic boxes into their components for proper cleaning.
- Uncouple the micro-implants insertion key from the handle (see diagram below).

2- Cleaning

- Immerse the instruments in a solution of a cleaning agent suitable for dental instruments to facilitate the removal of adhering biological debris.
- Remove biological residue manually with a soft brush and pH-neutral detergent.
- Rinse with plenty of water.
- Perform a final rinse with deionised water.
- Always use pH-neutral detergents and non-abrasive tools to clean surgical/prosthetic boxes so as not to damage the surfaces of the box.

3- Disinfection

- Immerse the instruments in a disinfectant explicitly indicated for dental instruments.
- For disinfection with ultrasonic equipment: immerse the material in the ultrasonic bath.
- Rinse with plenty of deionised water to remove any residues of the disinfectant.
- Dry the material with filtered compressed air.

IMPORTANT:

- Follow the instructions of the disinfectant manufacturer to determine concentrations and times.
- Follow the instructions of the manufacturer of the ultrasound equipment to determine temperature, concentration and times.

4- Inspection

- Check that the instruments are perfectly clean, otherwise repeat the above cleaning and disinfection steps.
- Discard instruments that show damage and replace them for the next surgery.
- Verify that the instruments and surgical/prosthetic boxes are perfectly dry before assembly and sterilisation.

Disassembly of ZIACOM® ratchets

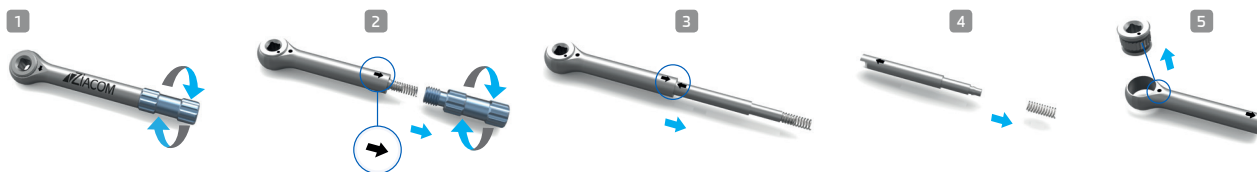

Assembly of ZIACOM® ratchets

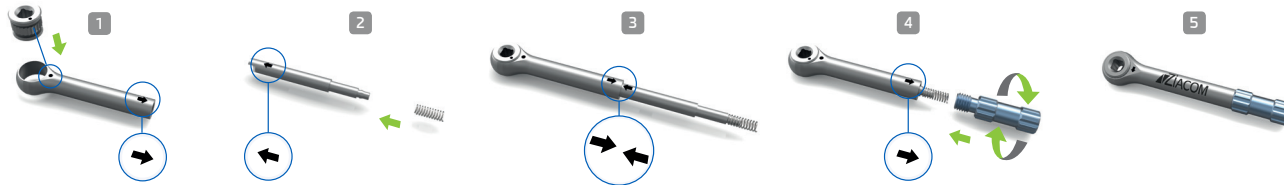

Disassembly of DSQ® micro-implant insertion handle



Assembly of DSQ® micro-implant insertion handle



Sterilisation instructions for: orthodontic micro-implants, abutments, instruments and boxes (surgical and prosthetic)

Protocol to be carried out by qualified personnel for the sterilisation of micro-implants, abutments, instruments and surgical/prosthetic boxes for use.

ATTENTION: all micro-implants, abutments, instruments and surgical/prosthetic boxes are supplied NON-STERILE. They should be sterilised as directed before the first clinical use.

They must be removed from their original packaging for sterilisation prior to first clinical use. Surgical/prosthetic instruments and boxes should be cleaned and disinfected after each use and sterilised prior to use. Do not sterilise instruments of different materials together, unless the corresponding surgical/prosthetic box is used correctly.

Steam autoclave sterilisation: sterilisation of micro-implants, abutments, instruments and boxes

- Insert the material individually into sterilisation bags and seal the bags.
For joint sterilisation: assemble the instruments in their corresponding surgical box, insert the box in a sterilisation bag and seal the bag.
- Place the bags to be sterilised in the autoclave.
- Sterilise in steam autoclave at 134°C/273°F (max. 137°C/276°F), for 4 min (minimum) and 2 atm of pressure.
Only for USA: the validated and recommended sterilisation cycle is in a steam and gravity autoclave at 132°C/270°F, minimum 15 minutes and drying time 15-30 minutes.

IMPORTANT:

- Make sure that the drying phase is completed to prevent the products from coming out wet.
- Check the sterilisation equipment if the sterilisation material or bags are wet at the end of the sterilisation.
- Carry out the maintenance of the autoclave with the established periodicity and the necessary actions, following the manufacturer's instructions.

Conservation of ZIACOM® products (micro-implants, abutments, instruments and boxes)

- Keep the products in the original ZIACOM® packaging in a dry and clean environment until use.
- After sterilisation, keep the products (micro-implants, instruments, abutments and surgical boxes) in their sealed sterilisation bags and in a dry and clean environment.
- Never exceed the expiration dates determined by the manufacturer of the sterilisation bags.

IMPORTANT:

- Follow the instructions of the manufacturer of the sterilisation bags.

General recommendations

- Never use damaged or dirty material. Never reuse products indicated for a single use, the user is responsible for the correct follow up of the instructions described in this document.
- Always wear gloves when cleaning the material.
- Follow the safety instructions given by the manufacturer of the disinfection agent.
- Sterility cannot be guaranteed if the sterilisation bag is open, damaged or wet.
- Respect all phases of the steriliser. If the sterilisation material or bags have water or moisture residues, check the autoclave and dry the bags.
- Carry out the maintenance of the autoclave according to its manufacturer, with the established periodicity.
- The sterilisation, cleaning and disinfection processes progressively deteriorate the instruments. Inspect the instruments carefully for signs of deterioration.
- Ziacom Medical SLU recommends following these instructions to avoid impairing the purpose and safety of its products. If alternative procedures are used, it is the responsibility of the user to ensure that the chosen cleaning, disinfection and sterilisation procedure achieves the desired results without affecting the products.

Note. For the most up-to-date version of the cleaning, disinfection and sterilisation instructions, please visit our website www.ziacom.es



Zinic®SHORTY



General sales conditions

Consult the general sales conditions updated in our web www.ziacom.es

All rights reserved. No part of this document may be reproduced or transmitted in any form or by any means, electronic or mechanical, in photocopies, on recordings, or in any other manner not provided herein without prior written permission of the owner of the trademark rights, edition and printing. ZIACOM® is a registered trademark of Ziacom Medical SLU.

Important

- For the latest version of our catalogues, please visit our website at www.ziacom.es
- Check the availability of each product for country.



Sede Central Europa | Europe Headquarters
Ziacom Medical SLU
Calle Búhos, 2
28320 Pinto - Madrid - ESPAÑA
Tfno.: +34 91 723 33 06
info@ziacom.es - www.ziacom.es

Sede Central América | America Headquarters
Ziacom Medical USA LLC
333 S.E. 2nd Avenue, Suite 2000
Miami, FL 33131 - USA
Tel: +1 (786) 224 - 0089
info.usa@ziacom.es - www.ziacom.es