

Regenerative

Biomaterials, pin system, fixation screws and mesh membranes



Regenerative

Biomaterials, pin system, fixation screws and mesh membranes



Important information

Please read carefully before using Ziacom® products

General information

This document contains basic information on the use of original Ziacom® dental implant systems, hereafter referred to as Ziacom® dental implants or simply Ziacom® products. This document has been created as quick guide for clinicians responsible for treatment, hereafter the "user", and, therefore, is neither an alternative nor a substitute for specialized training or professional clinical experience.

Ziacom® products must be used according to a suitable treatment plan and adhering strictly to the surgical and prosthetic protocols established by the manufacturer. Read the product-specific surgical and prosthetic protocols as well as the instructions for use and maintenance before using each Ziacom® product. You can find this information on our website, www.ziacom.com, or request it from your nearest authorised Ziacom® distributor.

Liability, safety and guarantee.

The instructions for the use and handling of Ziacom® products are based on internationally published literature, current clinical standards and our clinical experience, so they should be understood as general guiding information. The handling and use of Ziacom® products is the sole responsibility of the user as it is outside the control of Ziacom Medical SL. Ziacom Medical SL, their affiliates and/or their authorised distributors disclaim all responsibility, whether explicit or implicit, total or partial, for possible damage or injury caused by poor handling of the product or any other situation not considered in their protocols and manuals for the correct use of their products.

The user must ensure that the Ziacom® product is appropriate for the intended procedure and end purpose. Neither these instructions for use nor the work or handling protocols for the products release the user from this obligation. Ziacom® products must be used, handled and applied by professionals with the appropriate training and qualifications required according to current legislation in each country.

The total or partial use, handling and/or application of Ziacom® products at any stage of their implementation by personnel who are unqualified or lack the necessary training will automatically void any type of warranty and may cause severe damage to the patient's health.

Ziacom® products are part of their own system, with their own design characteristics and work protocols, including dental implants, abutments or prosthetic components and surgical or prosthetic instruments. The use of Ziacom® products in combination with elements or components from other manufacturers could result in treatment failure, damage to tissues or bone structures, inadequate aesthetic outcomes and severe damage to the patient's health. Therefore, only original Ziacom® products should be used.

The clinician in charge of the treatment is solely responsible for ensuring the use of original Ziacom® products and that they are used according to the corresponding instructions for use and handling protocols throughout the implant procedure. The use of any other non-original Ziacom® components, instruments or products, whether alone or in combination with any original Ziacom® products, will immediately void the warranty of the original Ziacom® products.

See the Ziacom Medical SL Warranty Programme (available on the website or by contacting Ziacom Medical SL, their affiliates or authorised distributors).

Warning. Not all Ziacom® products are available in all countries. Check availability in your country.

The Ziacom® brand and the names of other products and services, including their logos, that are mentioned in this document or on the website www.ziacom.com, are registered trademarks of Ziacom Medical S.L.

Ziacom Medical S.L. reserves the right to modify, change, remove or update any of the products, prices or technical specifications referenced on this website or in any of its documents without prior notification. All rights reserved. The reproduction of this document, whole or in part and in any medium or format, without the corresponding written authorisation from Ziacom Medical SL is prohibited.





Index

La Compañía	06		
Together for health	06		
Ziacom® quality	06		
Grade 5 ELI titanium	06		
Investment in innovation and training	07		
Ziacom® around the world	07		
- Regional headquarter / Subsidiaries	07		
Regenerative			
XENOGRAFT bone graft	10		
RE-BONE® bovine bone graft	10		
RE-BONE® clinical applications	11		
RE-BONE® presentations	12		
- Granules	12		
- Block	13		
SYNTHETIC bone graft	16		
Osseos BCP® synthetic bone graft	16		
Osseos BCP® clinical applications	16		
Osseos TCP® synthetic bone graft	17		
Osseos TCP® clinical applications	17		
Membranes	20		
SHELTER® SLOW xenograft membrane	20		
SHELTER® SLOW clinical applications	21		
SHELTER® SLOW indications	22		
T-Gen® resorbable collagen membrane	23		
T-Gen® clinical applications	23		
Zellplex® synthetic membrane	24		
Zellplex® clinical applications	24		
		ZS1 fixation pin	26
		Characteristics	26
		Recommendations for use	27
		Diameters, lengths and references	27
		Product presentation	28
		Instructions for opening ZS1 fixation pins	28
		How to use this catalogue	29
		- Product sheet / Symbology	29
		Surgical instruments	32
		Surgical protocol	34
		ZS2 short bone fixation screw	38
		Characteristics	38
		Recommendations for use	39
		Diámetros, longitudes y referencias	39
		Product presentation	40
		Instructions for opening ZS2 short screws	40
		Surgical instruments	42
		Surgical protocol	44
		ZS2 long bone fixation screw	48
		Characteristics	48
		Recommendations for use	49
		Diameters, lengths and references	49
		Product presentation	50
		Instructions for opening ZS2 long screws	50
		Surgical instruments	52
		Surgical protocol	54
		ZS3 titanium mesh membrane	58
		Characteristics / References and dimensions	58
		Recommendations for use	59
		Instruments	59
		Surgical protocol	62
		ZS3 honeycomb titanium mesh membrane	66
		Characteristics / References and dimensions	66
		Recommendations for use	66
		Instruments	67
		Surgical protocol	70
		Other products	74
		Cleaning, disinfection and sterilisation	78

The Company

Together for health

Ziacom® has been working for more than 20 years to improve the **oral health** and well-being of patients around the world by **designing and manufacturing innovative**, high-quality dental implant, prosthetic component, surgical instrument and biomaterial solutions.

The company was founded in 2004 with **100% Spanish capital** and began its activity as a manufacturer of dental implants and attachments for several European companies before launching its own **brand of implant systems** in 2006.

In 2015, Ziacom® introduced its **diversification strategy** with the development of **new business lines** and new product lines and the launch of a **new portfolio**, which helped the company achieve a **15% share of the Spanish market** in 2016 with the sale of more than 230.000 implants.

In 2022, the company started up on an **ambitious growth plan** with new goals of **international expansion**, broadening and **diversification** of its portfolio of **products and services** and a Corporate Identity restyle.

Ziacom® quality

Commitment to **quality and innovation** has been part of the values and the essence of Ziacom® since the beginning.

The reason why we used state-of-the-art technology in **every stage of our products' production cycle**, from **design and manufacture to quality assurance, cleaning and packaging**. All of our products are also manufactured using only **high-quality raw materials** after applying **strict controls to select** our main suppliers.

Ziacom Medical SL is a **licensed manufacturer of medical devices** and an AEMPS (Spanish Agency for Medicines and Medical Devices) 6425-PS **marketing authorisation holder**. Our **quality management**

system is certified in accordance with the requirements of ISO standards 9001:2015 and 13485:2018, and is also GMP 21 CFR 820 compliant.



Thanks to our ceaseless endeavours to offer our clients an unsurpassable quality, all our implants have a **lifetime guarantee**.

See the General Conditions for Accessing the Guarantee for Ziacom® products.

Grade 5 ELI titanium

The **Ziasure** fixation system by Ziacom® is made from **Grade 5 ELI titanium (medical grade) Ti 6Al 4V** and **Grade 2 titanium (medical grade)**, which offer better mechanical properties. The **Ziasure** fixation system by Ziacom® is marketed in an unsterilised condition.

Thanks to the **Grade 5 ELI titanium and the Grade 2 titanium**, our products meet the requirements of standards ASTM F136 and ISO 5832-3 and comply with the requirements of EU Regulation 2017/745, attaining the corresponding CE marking from notified body 0051.



*See approved models

IMPORTANT

All the products listed in this Ziacom® catalogue are supplied unsterilised and must be sterilised before use.



Investment in innovation and training

In order to always offer the very best solutions for the **well-being of every patient**, and thanks to the experience and dedication of our **highly-qualified professionals** and **innovative Technological Centre**, our R&D&I team works incessantly in the field of **research and innovation** to **improve** our products and develop **new solutions** to meet the demands and needs of both patients and dentists.

We also invest in **research** and **ongoing training** as a way of providing **scientific support to the sector** and we firmly believe in training **young professionals** to ensure the best **advances in dentistry field**.

We therefore work closely with **training centres, universities and scientific bodies** to create a practical and specialised teaching environment to promote and strengthen their knowledge, abilities and professional growth.

In order to enhance our investment in the training and **development of dental professionals**, we have **specific areas at our facilities** for **hands-on training and practicals, state-of-the-art** training equipment and also a **physical and virtual showroom** where professionals can see all our dental solutions first hand.

Ziacom® around the world

We are committed to making oral health available to patients all over the world and have a solid **internal growth and expansion plan** to increase the company's **international presence** in those **areas where we our products are already available** and to add **new growth areas**.

In order to achieve this, we offer our **international associates** a **trusting and collaborative** partnership by adapting to their **local needs** and providing solutions that are specific to each market.

As part of our commitment to meet the specific **quality, regulatory and legal requirements of each country**, for both the registration and distribution of our products, we have **specific certifications** from each of the countries in which we trade.

Regional headquarter

Ziacom Medical SL

Madrid - ESPAÑA
Calle Búhos, 2 - 28320 Pinto
Tel: +34 91 723 33 06
info@ziacom.com

Subsidiaries

Ziacom Medical Portugal Lda

Av. Miguel Bombarda, 36 - 5º B
1050 -165 - Lisboa - PORTUGAL
Tel: +351 215 850 209
info.pt@ziacom.com

Ziacom Medical USA LLC

Miami - EEUU
333 S.E 2nd Avenue, Suite 2000
Miami, FL 33131 - USA
Phone: +1(786) 224 - 0089
info.usa@ziacom.com

Please see the up-to-date list of Ziacom® distributors at www.ziacom.com or email us at export@ziacom.com





Regenerative

XENOGRAFT bone graft



XENOGRAFT bone graft

RE-BONE® bovine bone graft

Ziacom® and UBGEN® present this cortical-cancellous bone xenograft, enhancing the winning characteristics of bovine bone substitute with the innovative low-temperature Thermagen production process. Thanks to this protocol, we are able to avoid the so-called "sintering" (transformation into ceramic) of the bone substitute, thus ensuring its total resorption, high biocompatibility and adequate macro/microporosity.

The Thermagen starting material decellularisation process was developed by a team of internal and external bioengineering experts, with multiple tests performed by authoritative university departments.

Together with the Thermagen production process, the choice of starting material is what really makes the difference: from the quality of the land used for grazing, to the organic crops used to produce animal feeds, and even the condition of the facilities where animals are housed.

If animals live and grow in a healthy environment and their natural habitats are respected, the resulting products will intrinsically meet health and safety requirements.

We recommend rehydrating RE-BONE with liquid PRF or blood.

"RE-BONE® is a bone substitute that is very similar to human bone tissue. It is therefore able to create an environment favourable to chemotaxis, osteoblast proliferation and neoangiogenesis by maintaining the native three-dimensional structure of the extracellular matrix." ¹

¹ Gardin C, Ricci S, Ferroni L, Guazzo R, Sbricoli L, DeBenedictis G, Finotti L, Isola M, Bressan E, Zavan B. Decellularization and Delipidation Protocols of Bovine Bone and Pericardium for Bone Grafting and Guided Bone Regeneration Procedure PLOS ONE | DOI:10.1371/journal.pone.0137171 July 20, 2015.



RE-BONE® clinical applications

- Preservation of the alveolus and alveolar ridge

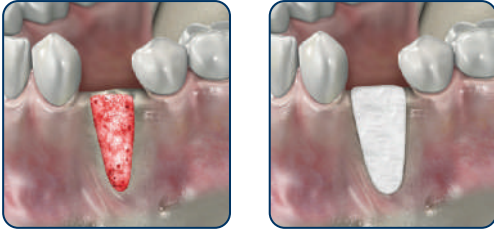

- Sinus lift



- Augmentation of ridges with bone defects



- Treatment of dehiscence and fenestration in peri-implant lesions



- Periodontal regeneration



XENOGRAFT bone graft

RE-BONE® presentations

■ Granules:

■ GRANULOMETRY

The granulometry of our bone substitute varies from 0.25 mm to 2 mm, thus favouring osteoblast migration to generate new bone.

Granules - 0.25 - 1 - 195X

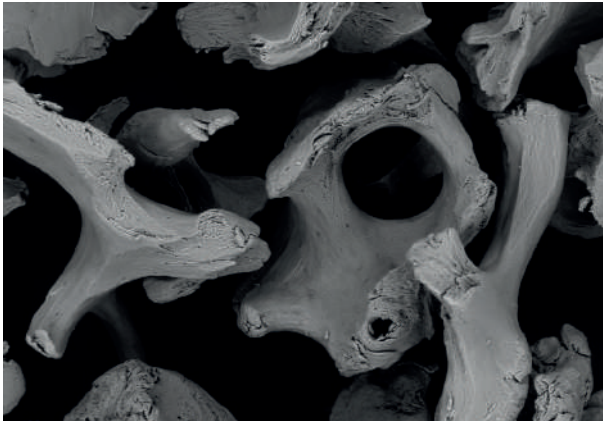

GRANULES			
CODE	DESCRIPTION	SIZE IN G	SIZE IN CC
BMrebone01B	Cortical-cancellous granules 0.5 g - 0.25-1 mm: box of 1	0.5 g	0.90 cc
BMrebone01C	Cortical-cancellous granules 1 g - 0.25-1 mm: box of 1	1g	1.80 cc
BMrebone01D	Cortical-cancellous granules 2 g - 0.25-1 mm: box of 1	2 g	3.60 cc
BMrebone01F	Cortical-cancellous granules 1 g - 1-2 mm: box of 1	1g	1.90 cc
BMrebone01G	Cortical-cancellous granules 2 g - 1-2 mm: box of 1	2 g	3.80 cc

■ Block:



BLOCK			
CODE	DESCRIPTION	SIZE IN G	SIZE IN CC
BMrebone02A	Block - 10x10x10 mm (cancellous)	-	-



Regenerative

SYNTHETIC bone graft

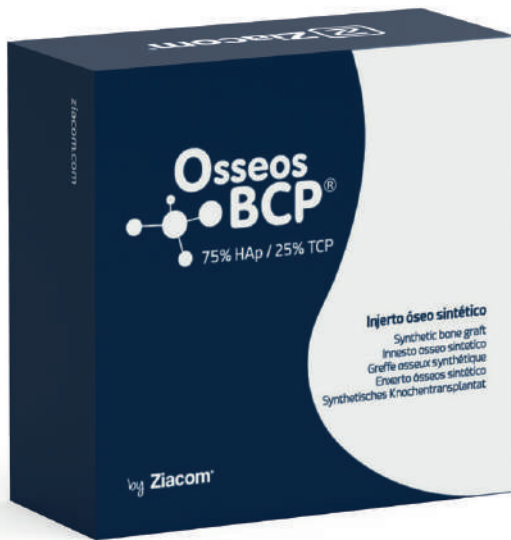

SYNTHETIC bone graft

Osseos BCP[®] synthetic bone graft

Osseos BCP[®] is a fully synthetic, two-phase bone graft material containing 75% hydroxyapatite (HA) and 25% beta-tricalcium phosphate (β -TCP). Its multi-directional interconnected porosity promotes three-dimensional bone regeneration, with a pore size of 300 to 500 microns. As the bone healing process occurs, Osseos BCP[®] is resorbed and replaced by new bone. Due to its composition, Osseos BCP[®] shows two-phase resorption.

Due to its slow resorption rate, Osseos BCP[®] is replaced by new bone over a period of 6 to 24 months, allowing the volume of the tissues to be maintained for longer.

The composition of Osseos BCP[®] makes it easy to handle thanks to its high degree of hydrophilicity and cohesion, and also promotes correct bone vascularisation.

Osseos BCP[®] clinical applications

- Filling bone defects not intrinsic to the stability of the bone structure.

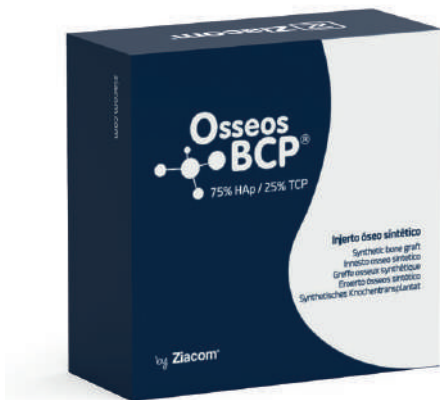

Reference	Geometry	Dimensions	Quantity
OEBO10505G	Granules	0.1 - 0.5 mm	0.5 g/1 unit
OEBO50110G	Granules	0.5 - 1 mm	1.0 g/1 unit

Osseos TCP® synthetic bone graft

Osseos TCP® is a fully synthetic bone graft material containing pure beta-tricalcium phosphate (β -TCP). Its multi-directional interconnected porosity promotes three-dimensional bone regeneration, with a pore size of 300 to 500 microns. As the bone healing process occurs, Osseos TCP is resorbed and replaced by high-quality new bone over the course of 1 to 6 months thanks to its high degree of porosity (80%), without compromising mechanical stability.

The composition of Osseos TCP® makes it easy to handle due to its high degree of hydrophilicity and cohesion, and also promotes correct bone vascularisation.

Osseos TCP® clinical applications

- Filling bone defects not intrinsic to the stability of the bone structure.



Reference	Geometry	Dimensions	Quantity
OET010505G	Granules	0.1 - 0.5 mm	0.5 g/1 unit
OET050110G	Granules	0.5 - 1mm	1.0 g/1 unit



Regenerative

Membranes



SHELTER® SLOW xenograft membrane

Slow-resorbing bovine pericardium membrane (4-6 months) thanks to the reinforced bonds between the collagen fibres, made more resistant by the Pericross cross-linking process.

In its thicker version, it can replace non-resorbable solutions in some types of surgery, with the benefit of being fully resorbable, thus avoiding a second removal surgery.

SHELTER® SLOW is occlusive to the passage of cells. It is designed to promote osteoblastic and periodontal ligament cell proliferation, protecting the site from soft tissue colonisation. It is also stable and resistant to traction and is easy to use and handle during placement.

The SHELTER® SLOW membrane has been subjected to mechanical tensile testing, from which it was possible to obtain stress-strain curves with a characteristic trend of collagen materials. Thanks to the Pericross process in particular, the structure of the collagen fibres and other components, such as elastin, is kept intact.

Based on the results obtained, we can state that, even under hydrated conditions, SHELTER® SLOW presents the natural typical structure of the pericardium:

- A first region of fibrillar alignment.
- An area of resistance to stress.
- A third phase of gradual breaking with fibres that continue to hold the membrane together and in situ.

Membrane 100µm - cross-section - slow

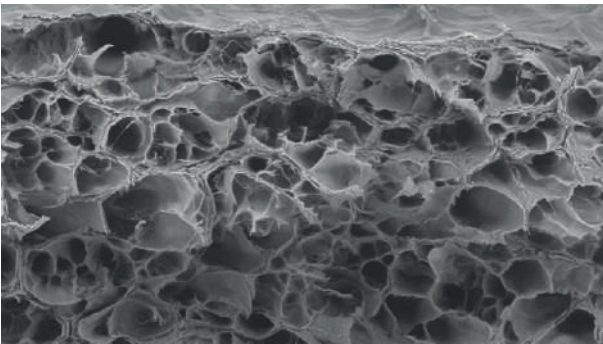

Membrane 20µm - cross-section - slow

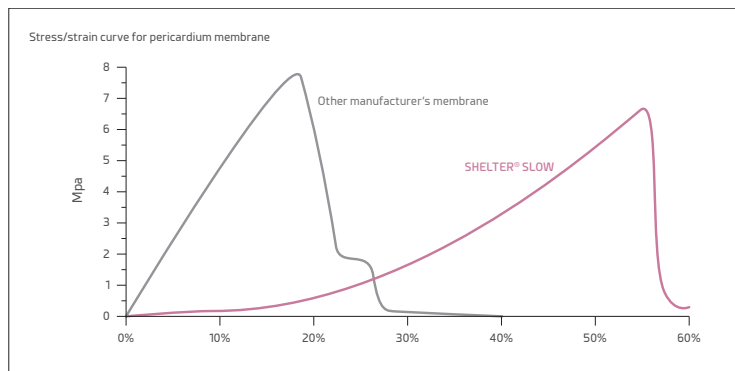
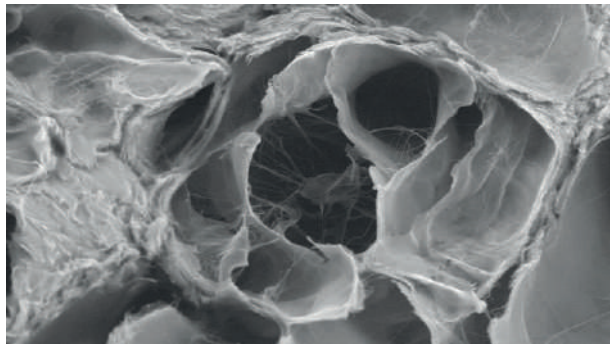

SHELTER[®] SLOW clinical applications

- Preservation of the alveolus and alveolar ridge.



- Sinus lift.



- Augmentation of ridges with bone defects.



- Treatment of dehiscence and fenestration in peri-implant lesions.



- Periodontal regeneration.



Membranes

SHELTER® SLOW indications



SLOW MEMBRANES				
CODE	DESCRIPTION	DIMENSIONS	THICKNESS	TYPE
BMSPshelter05A	Pericardium membrane 15x20x0.2 mm SLOW	15x20x0.2 mm	0.2 mm	SLOW
BMSPshelter05D	Pericardium membrane 15x20x0.4 mm SLOW	15x20x0.4 mm	0.4 mm	SLOW
BMSPshelter05G	Pericardium membrane 15x20x0.8 mm SLOW	15x20x0.8mm	0.8 mm	SLOW
BMSPshelter05E	Pericardium membrane 30x25x0.4 mm SLOW	30x25x0.4 mm	0.4 mm	SLOW
BMSPshelter05H	Pericardium membrane 30x20x0.8 mm SLOW	30x25x0.8 mm	0.8 mm	SLOW
BMSPshelter05F	Pericardium membrane 50x30x0.4 mm SLOW	50x30x0.4 mm	0.4 mm	SLOW
BMPPhelter05I	Pericardium membrane 50x30x0.8 mm SLOW	50x30x0.8 mm	0.8 mm	SLOW

T-Gen® resorbable collagen membrane

Resorbable collagen membrane of porcine origin. It can be used with bone grafts or be attached directly to the defect area.

The T-Gen® membrane allows good adaptation during graft covering due to its flexibility. It also gives an excellent regeneration result without any adverse reaction, such as perforation or infection of the soft tissue.

The T-Gen® resorbable collagen membrane provides a successful solution in cases where the patient's aesthetic region is compromised, thanks to its elastic properties.

Use of the T-Gen® membrane in complicated situations, in combination with a good surgical technique, allows a successful outcome with GBR and GTR techniques.

T-Gen® clinical applications

- Post-extraction alveolar regeneration
- Implant site preparation
- Treatment of fenestration defects
- Preservation of the alveolar ridge
- Sinus augmentation
- Protection of the sinus membrane against tears

T-Gen®



Prod. code	Dimensions
TG-1	15x20 mm
TG-2	20x30 mm

Membranes

Zellplex® synthetic membrane

Zellplex® is a polylactic-glycolic acid (PLGA) synthetic membrane that is biocompatible and fully resorbable. Zellplex® has a specially designed dual-layer structure, which avoids internal growth of epithelial tissue while promoting cellular infiltration, inducing bone regeneration. The Zellplex® membrane can be used on its own or together with bone substitutes.

Zellplex® clinical applications

- Post-extraction alveolar volume preservation
- Covering of the bone defect during immediate or delayed implant placement
- Alveolar ridge reconstruction

Zellplex®



Prod. code	Dimensions
ZP1520	15x20 mm
ZP2030	20x30 mm

Zs1

Fixation pin



Zs1 fixation pin

Ziacom® Ziasure ZS1 fixation pins have been developed to be used in guided bone regeneration (GBR) procedures. Their main function is the securing of membranes, both resorbable and non-resorbable.

The Ziasure ZS1 fixation pin provides immobilisation of the membrane, which promotes and improves predictability in bone regeneration processes.

Characteristics

HEAD

- Head $\varnothing 2.5$ mm: allows better distribution of the impacted force.
- Hexagonal 0.90 mm connection: allows the fixation pin to be removed once treatment has finished.
- Flat base: improves stability of the fixation pin and prevents the membrane from being cut or perforated.

BODY

- Anchor area: improves stability of the pin.
- Threaded area: facilitates removal of the fixation pin once treatment has finished.
- Overall lengths: 3.30 mm and 5.50 mm.

TIP

- Sharp tip: allows insertion into soft and hard bone without drilling.

MATERIAL

- Grade 5 ELI titanium (medical grade) Ti 6Al 4V

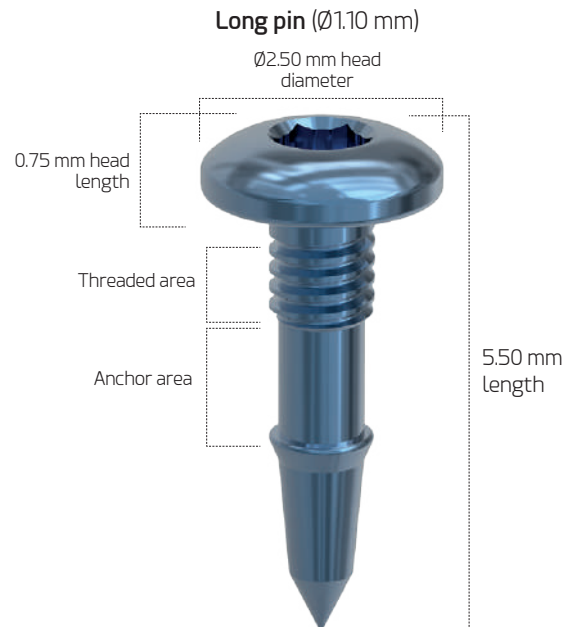
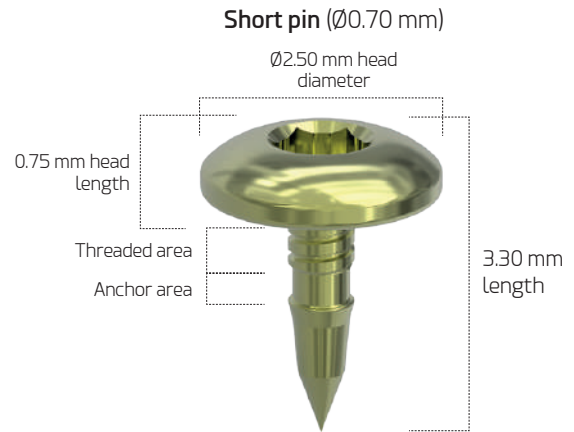

Recommendations for use

Ziacom® Ziasure® ZS1 pins are indicated for fixation and stabilisation of both resorbable and non-resorbable membranes during Guided Bone Regeneration (GBR) procedures.

There are two types of Ziacom® Ziasure® ZS1 pins:

ZS1 FIXATION PIN - 0.70x3.30 mm:

- Fixation of collagen, synthetic and PTFE (with or without Ti reinforcement) membranes in Seibert class I and II bone.





ZS1 FIXATION PIN - 1.10x5.50 mm:

- Fixation of collagen, synthetic and PTFE (with or without Ti reinforcement) membranes in Seibert class III and IV bone.
- Little fixation achieved with ZS1 3.30 mm pins.
- Fixation of grafts in mucogingival surgery.

NOTE

It is recommended that ZS1 fixation pins be removed once treatment has finished. Maximum duration of use is 12 months.

Diameters, lengths and references

		DIAMETER	LENGTH	HEAD Ø	ANODISED	REFERENCES	
						5 UNITS	10 UNITS
Ziasure ZS1 fixation pin - Short		0.70	3.30	2.50		PS3305	PS3310
Ziasure ZS1 fixation pin - Long		1.10	5.50			PS5505	PS5510

Dimensions in mm.

IMPORTANT

Ziasure ZS1 fixation pins are supplied non-sterile.

Zs1 fixation pin

Product presentation

Ziasure ZS1 fixation pins come in a carton sealed with a product label, allowing immediate identification. Each box contains:

- **Ziasure ZS1 fixation pin blister pack:** heat-sealed, with product labels for correct traceability. There is a flap for easy opening in the surgery while preventing accidental opening.
- **Product label information:** product code, diameter and length of the Ziasure ZS1 fixation pins, product description, batch number, manufacturer, date of manufacture and symbols identifying the product.

IMPORTANT

Ziasure ZS1 fixation pins must not be sterilised in their original packaging or with the plastic vial.

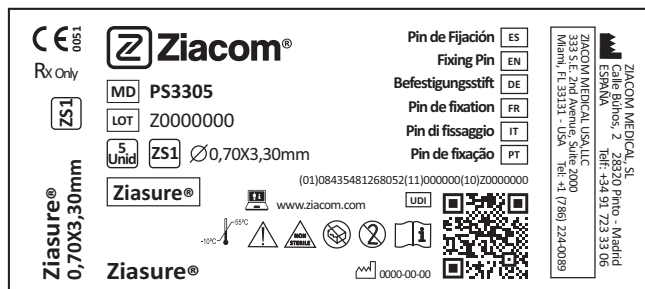

For full details on the product presentation and instructions for use (IFU), go to www.ziacom.es/ifus or scan the QR code on the box.



Description of the symbology used

- | | | | |
|--|--|--|-----------------------------------|
| | CE marking and notified body number. | | Do not resterilize. |
| | Medical device indicator. | | Do not use if package is damaged. |
| | Product batch number. | | Single-use product. |
| | Patient information website. | | See instructions for use. |
| | Temperature limit. | | Date of manufacture. |
| | Unique device identifier. | | Product manufacturer. |
| | Caution, consult accompanying documents. | | Prescription only. |
| | Non-sterile product. | | |

Instructions for opening ZS1 fixation pins

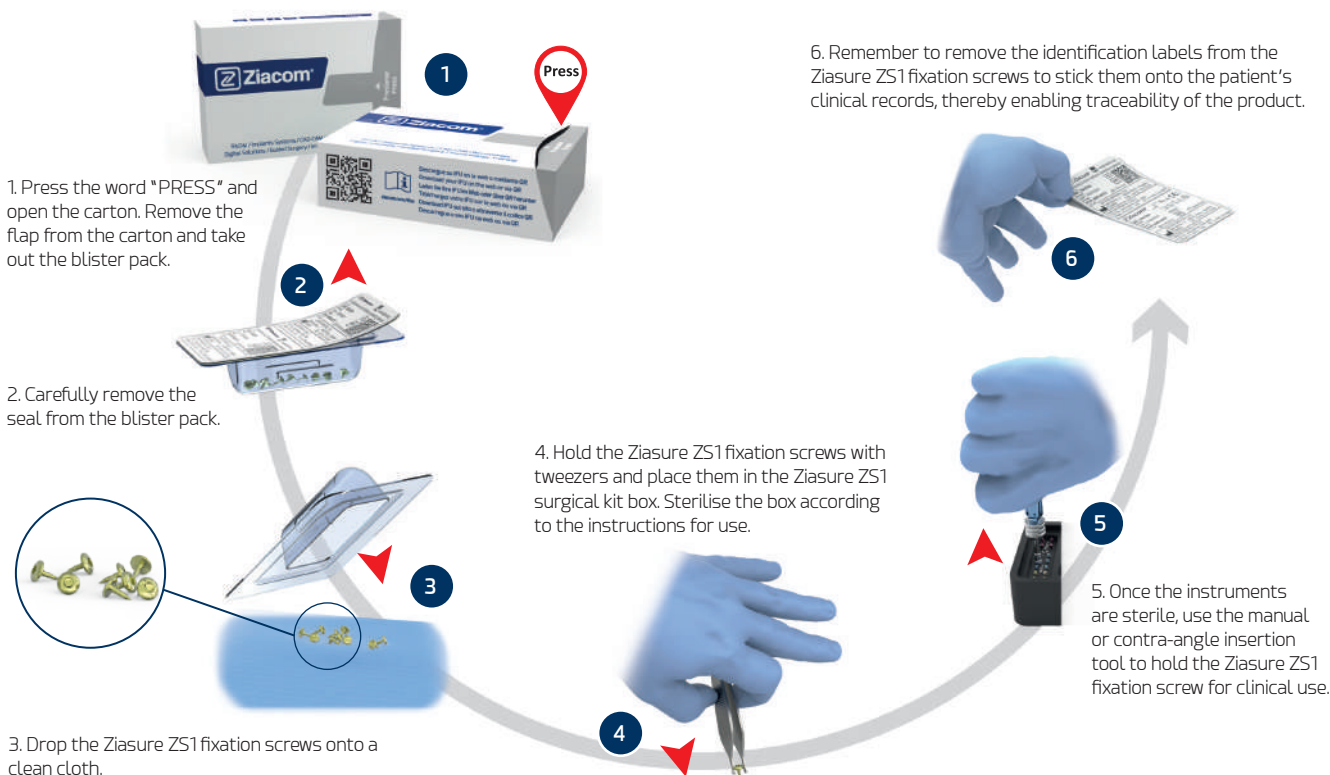

IMPORTANT

Ziasure ZS1 fixation pins are supplied unsterilised.

Product sheet

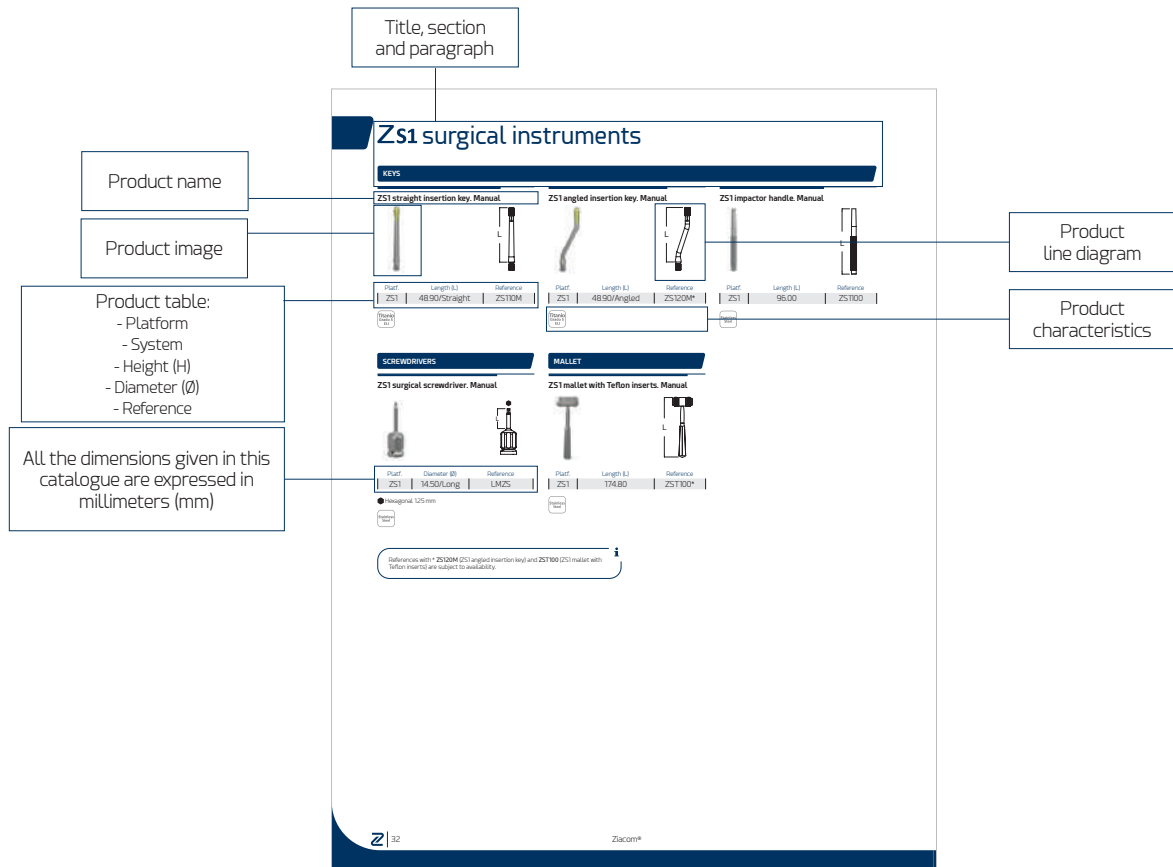

Symbology

Symbol	Meaning	Symbol	Meaning	Symbol	Meaning
	Rotatory element		Size in millimeters		Made from cobalt chromium + castable plastic
	Non-rotatory element		45° screw support		Made from cobalt chromium
	Use with manual torque		90° screw support		Made from PEEK
	Maximum operating torque		Use in rotation with a CA		Made from castable plastic
	Ratchet torque range		Maximum rotation speed		Made from plastic
	Galaxy connection		Maximum number of uses		Recommended sterilisation temperature
	Screw connection		Single-use product		Unsterilised product
	Kirator connection		Made from grade 5 ELI (extra-low interstitial) titanium		Use with abundant irrigation
	Basic connection		Made from grade 2 titanium		Use with abundant irrigation
	XDrive connection		Made from stainless steel		
	Tx30 connection		Fabricado en Acero		



Regenerative

Zs1 surgical
instruments

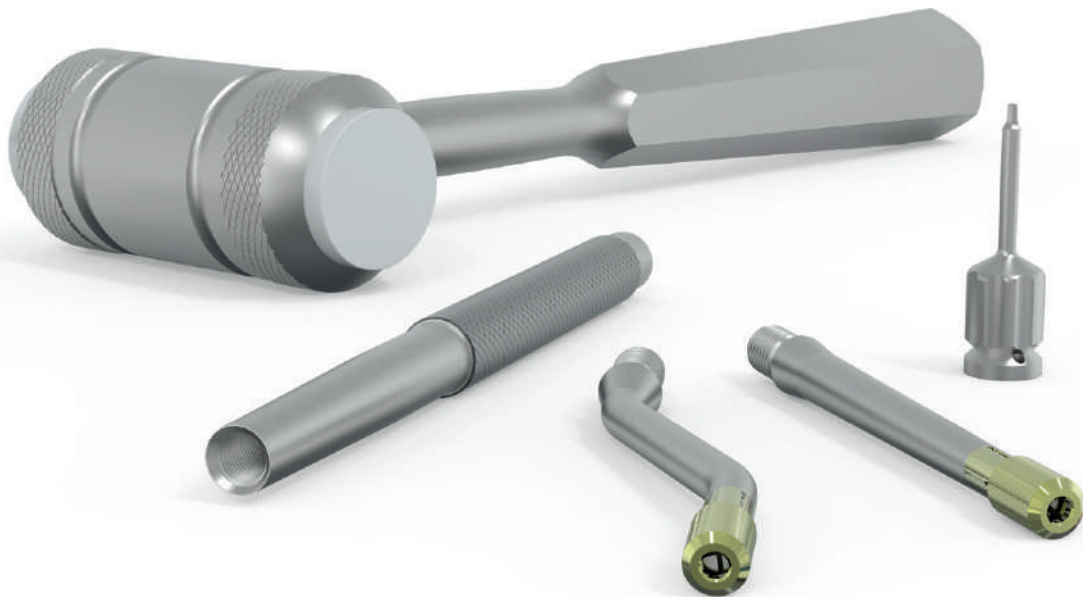

ZS1 surgical instruments

KEYS

ZS1 straight insertion key. Manual



Platf.	Length (L)	Reference
ZS1	48.90/Straight	ZS110M

Titanio
Grado 5
ELI

ZS1 angled insertion key. Manual



Platf.	Length (L)	Reference
ZS1	48.90/Angled	ZS120M*

Titanio
Grado 5
ELI

ZS1 impactor handle. Manual



Platf.	Length (L)	Reference
ZS1	96.00	ZS1100

Stainless
Steel

SCREWDRIVERS

ZS1 surgical screwdriver. Manual

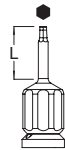

Platf.	Diameter (Ø)	Reference
ZS1	14.50/Long	LMZS

Hexagonal 1.25 mm

Stainless
Steel

MALLET

ZS1 mallet with Teflon inserts. Manual

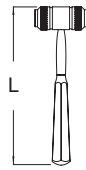

Platf.	Length (L)	Reference
ZS1	174.80	ZST100*

Stainless
Steel



References with * ZS120M (ZS1 angled insertion key) and ZST100 (ZS1 mallet with Teflon inserts) are subject to availability.

Zs1 surgical protocol

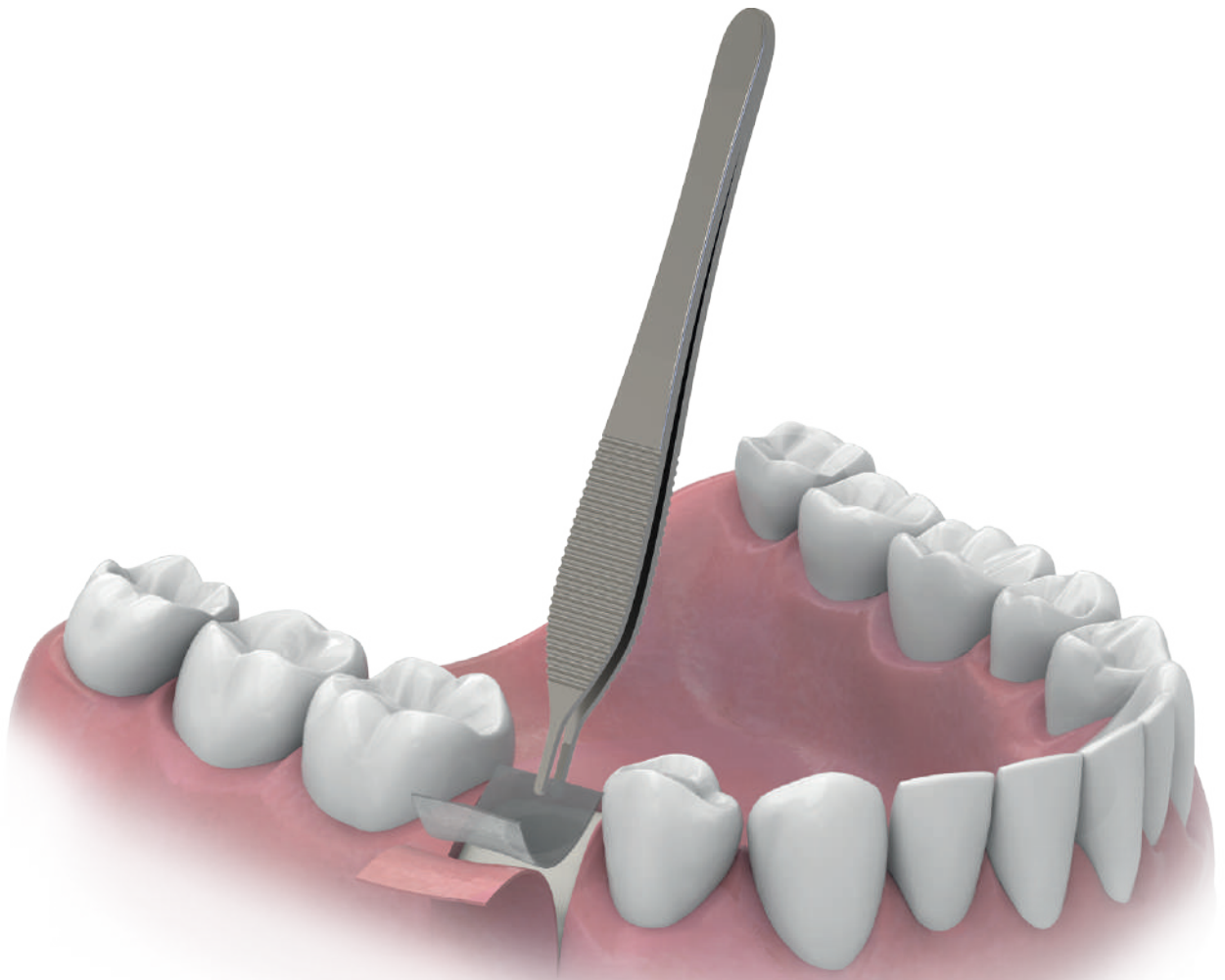

Zs1 surgical protocol

It is important to consider that Ziasure ZS1 fixation pins should be placed into alveolar bone and the placement protocol will depend on the fixation required, the type of bone, the type of membrane or graft, the position of tooth roots and other anatomical structures.

Steps for placing ZS1 fixation pins

Ziasure

- **EXAMPLE:**
Ziasure ZS1
fixation pins
Ø0.70x3.30mm



INTRODUCTION | Material required

1. ZS1 Straight insertion key (Ref. ZS110M)
2. ZS1 Angled insertion key (Ref. ZS120M)
3. ZS1 impactor handle (Ref. ZS1100)
4. ZS1 surgical screwdriver (Ref. LMZS)
5. ZS1 mallet with Teflon inserts (Ref. ZST100)



STEP 1

Take the impactor handle in the palm of your hand and screw the straight insertion key in until it is secure.

NOTE

For clinical situations where correct positioning of the instrument is impeded, use of the interchangeable angled insertion key is recommended.



STEP 2

Use the Impactor handle with the insertion key to insert the Ziasure ZS1 fixation pin by exerting pressure on the pin head, ensuring that it is tight.

NOTE

Remove the yellow protector from the insertion key prior to use.

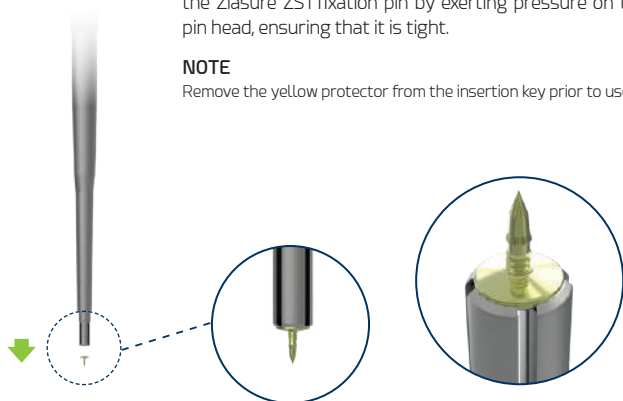

STEP 3

After placing the membrane in the desired position, select the site for the Ziasure ZS1 fixation pin and place it perpendicular (90° angle) to the surface.

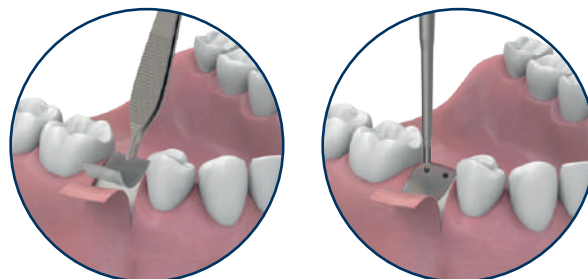

STEP 4

By gently tapping the mallet on the impactor handle, insert the Ziasure ZS1 fixation pin until the base of the head comes into direct contact with the membrane.



STEP 5

Remove the impactor with extreme care to avoid any lateral movements that may affect its stability.

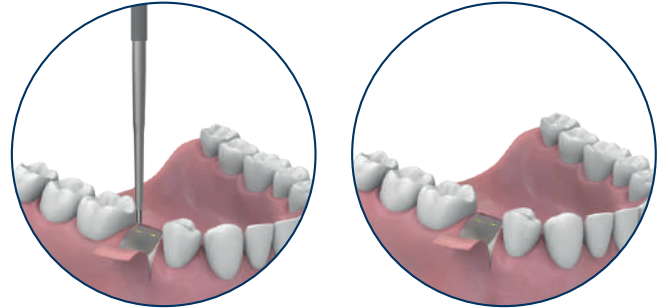

NOTE

In order not to affect the stability of the Ziasure ZS1 fixation pin, it is best to insert a scalpel blade into the impactor slot and to use this blade to hold the pin in position while removing the impactor.

STEP 6

On completing the bone regeneration treatment, remove the fixation pin by using the screwdriver to turn the fixation pin slightly anti-clockwise and, using tweezers, remove it from the surgical area.

NOTE

The time to remove the pin will depend on the type of biomaterial used in the bone regeneration procedure.

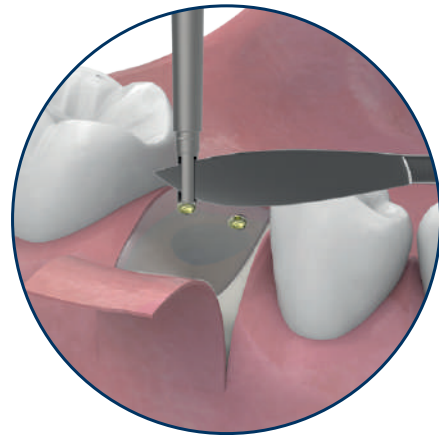
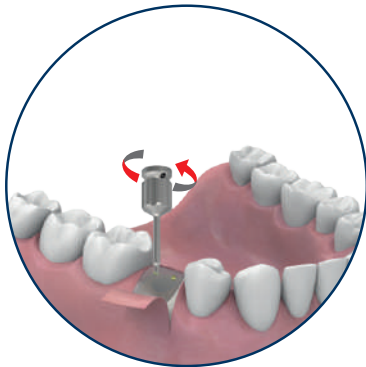



Regenerative

Zs2

Short bone fixation screws

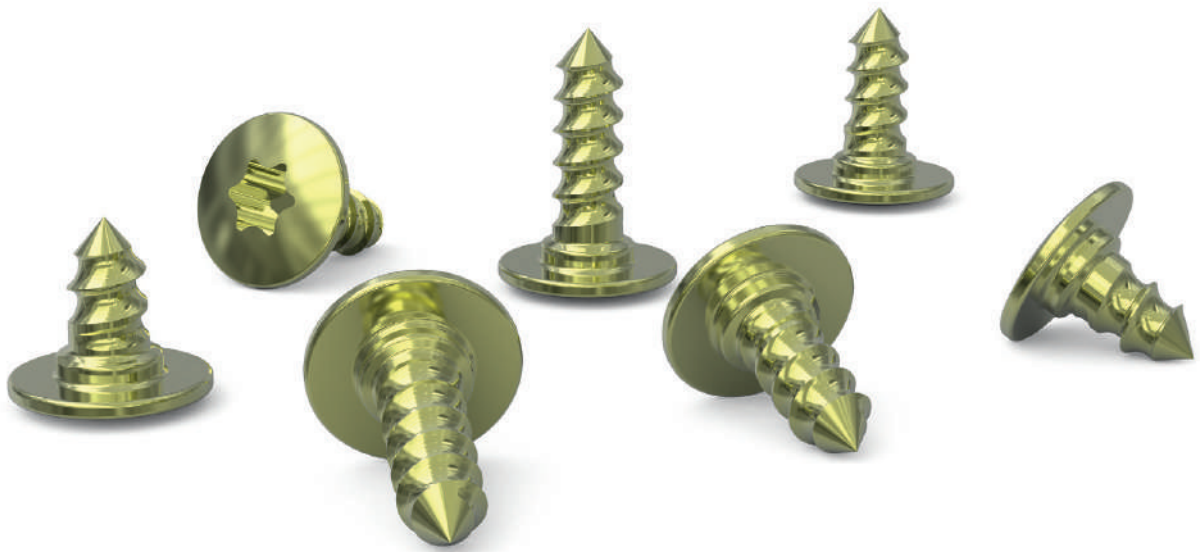

Zs2 short bone fixation screws

Ziacom® Ziasure ZS2 fixation screws are designed to be used in Guided Bone Regeneration (GBR) procedures as devices for securing and immobilisation of bone or soft tissue grafts, resorbable and non-resorbable membranes.

Characteristics

HEAD

- Flat base: improves membrane fixation and stability.
- Torx connection: facilitates insertion and removal once the treatment is finished.

BODY

- Anchor area: improves stability of the pin.
- Threaded area: facilitates removal of the fixation pin once treatment has finished.
- Overall lengths: 3.60 / 4.60 / 5.60 mm.

TIP

- Sharp tip: allows insertion into soft and hard bone without drilling.

MATERIAL

- Grade 5 ELI titanium (medical grade) Ti 6Al 4V

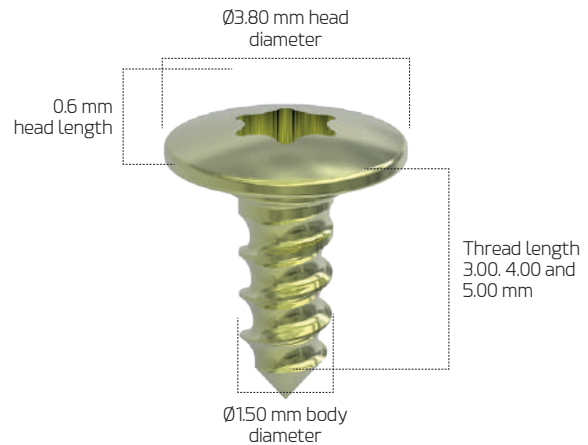





Recommendations for use

- Ziacom® Ziasure® ZS2 short bone fixation screws are indicated for fixation and stabilisation of both resorbable and non-resorbable membranes during Guided Bone Regeneration (GBR) procedures.
- Fixation of collagen, synthetic and PTFE (with or without Ti reinforcement) membranes in Seibert class I and II bone.
- Fixation of grafts in bone regeneration procedures and mucogingival surgery.

NOTE

It is recommended ZS2 fixation pins be removed once treatment has finished. Maximum duration of use is 12 months.

Diameters, lengths and references

		DIAMETER	LENGTH	HEAD Ø	ANODISED	REFERENCES	
						5 UNITS	10 UNITS
Ziasure ZS2 short bone fixation screw		1.50	3.00	3.80		PS150305	PS150300
			4.00			PS150405	PS150400
			5.00			PS150505	PS150500

Dimensions in mm.

IMPORTANT

Ziasure ZS2 fixation pins are supplied unsterilised.

Zs2 short bone fixation screws

Product presentation

Ziasure ZS2 short bone fixation screws come in a carton sealed with a product label, allowing immediate identification. Each box contains:

- **Ziasure ZS2 short bone fixation screw blister pack:** heat-sealed, with product labels for correct traceability. There is a flap for easy opening in the surgery while preventing accidental opening.
- **Product label information:** product code, diameter and length of the Ziasure ZS2 short bone fixation screws, product description, batch number, manufacturer, date of manufacture and symbols identifying the product.

IMPORTANT

Ziasure ZS2 short bone fixation screws must not be sterilised in their original packaging or with the plastic vial.

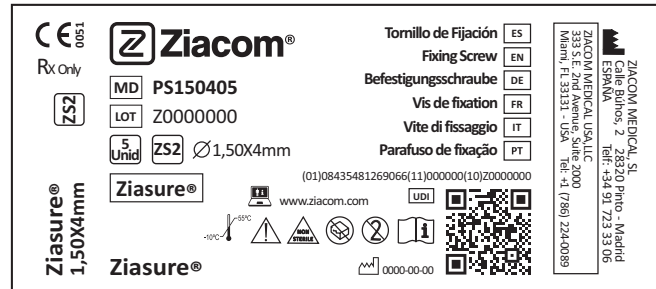

Description of the symbology used

- | | | | |
|--|--------------------------------------|--|-----------------------------------|
| | CE marking and notified body number. | | Do not resterilize. |
| | Medical device indicator. | | Do not use if package is damaged. |
| | Product batch number. | | Single-use product. |
| | Patient information website. | | See instructions for use. |
| | Temperature limit. | | Date of manufacture. |
| | Unique device identifier. | | Product manufacturer. |
| | Caution, accompanying documents. | | Prescription only. |
| | Non-sterile product. | | |

For full details on the product presentation and instructions for use (IFU), go to www.ziacom.es/ifus or scan the QR code on the box.

Instructions for opening ZS2 short screws

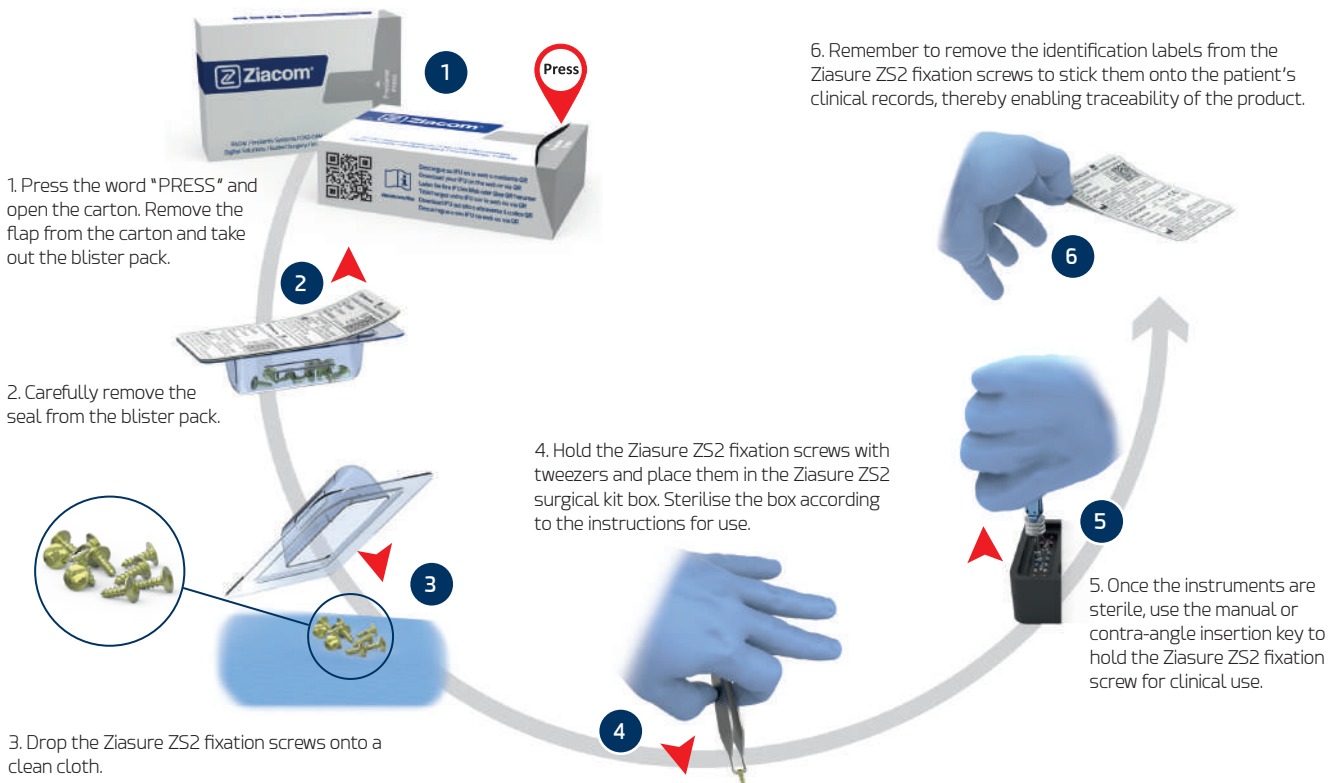

IMPORTANT

Ziasure ZS2 fixation screws are supplied unsterilised.

Zs2 surgical
instruments



Zs2 surgical instruments

SURGICAL DRILLS

ZS2 surgical drill. CA



Type	Diameter (Ø)	Length (L)	Reference
ZS2	0.80	12.50	OTZS208*
	1.20	12.50	OTZS212*
	1.70	12.50	OTZS217*

References with * OTZS208/OTZS212/OTZS217 (ZS2 surgical drills) are subject to availability.



KEYS

ZS2 insertion key. Manual



Type	Length (L)	Reference
ZS2	14.50	ZS210M

★ Torx connection / ■ Square 4x4 mm



ZS2 insertion key. CA



Type	Length (L)	Reference
ZS2	15.00	ZS220M

★ Torx connection



ZS2 insertion key for driver handle



Type	Length (L)	Reference
ZS2	14.50	ZS300M

★ Torx connection



DRIVER HANDLE

ZS2 driver handle



Type	Length (L)	Reference
ZS2	110.00	MDSQ



Zs2 surgical protocol

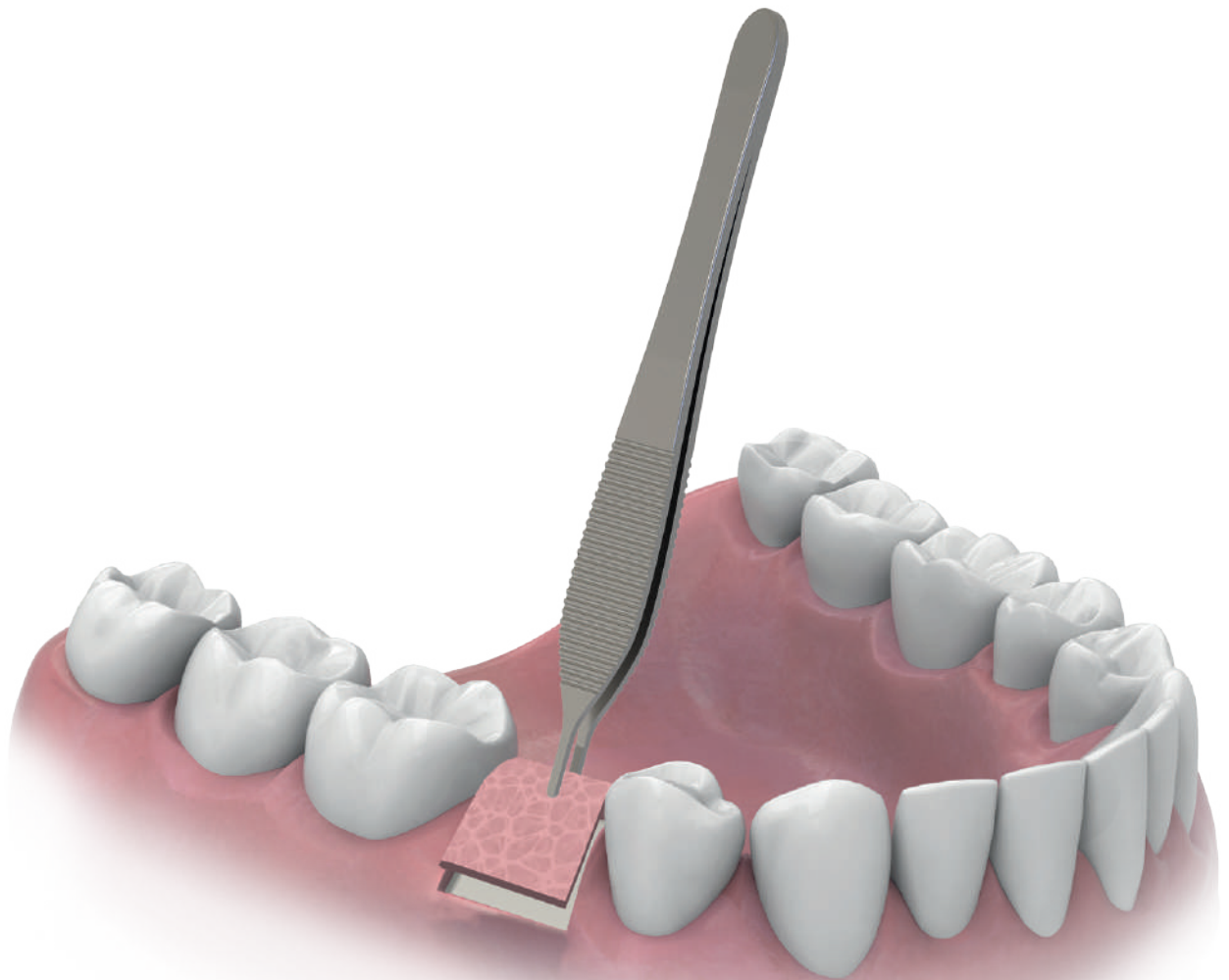

Zs2 surgical protocol

It is important to consider that Ziasure ZS2 fixation screws should be placed into alveolar bone and the placement protocol will depend on the fixation required, the type of bone, the type of membrane, mesh membrane or graft, the position of tooth roots and other anatomical structures.

Steps for placing ZS2 short screws

Ziasure

- EXAMPLE:
Ziasure ZS2
short fixation
screws
Ø1.50x4.00 mm

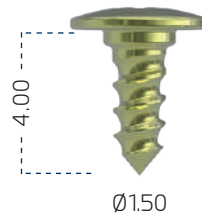

INTRODUCTION | Material required

1. Ziasure ZS2 insertion key manual (Ref. ZS210M)
2. Ziasure ZS2 insertion key CA (Ref. ZS220M)
3. ZS2 insertion key for driver handle (Ref. ZS300M)
4. ZS2 driver handle (Ref. MDSQ)



STEP 1

Hold the driver handle at its widest point in the palm of your hand and use your index finger and thumb to pull back the ring. Push the Ziasure ZS2 insertion key in until it is correctly seated and let the ring go.

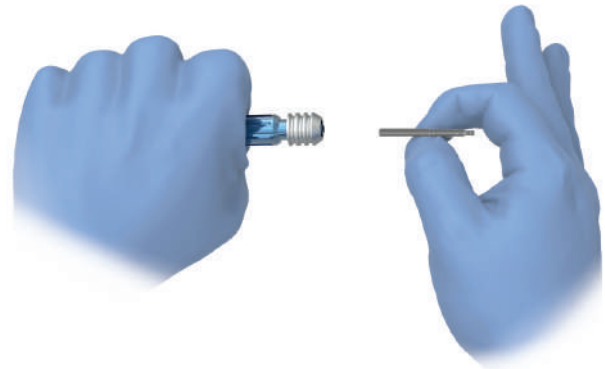

STEP 2

Use the Ziasure ZS2 insertion key with the handle or the Ziasure ZS2 insertion key for contra-angle to pick up the Ziasure ZS2 short fixation screw. Make sure the screw is tight.



STEP 3

Once the membrane, mesh membrane or graft is in position, select the site where fixation is required and place the Ziasure ZS2 short fixation screw perpendicular (90° angle) to the surface.

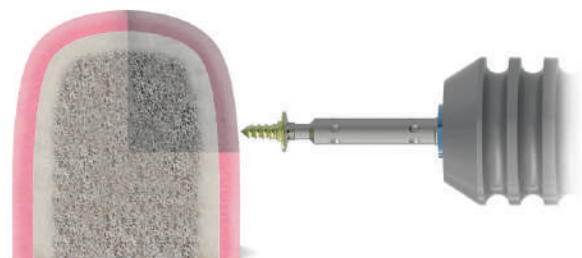

STEP 4

Exert firm pressure and turn the Ziasure ZS2 insertion key in the handle clockwise with the contra-angle set to a rate of 25 rpm using a torque of 15 Ncm or less.

NOTE

Use of more than one ZS2 fixation screw is recommended to stabilise the membrane, titanium mesh membrane or graft.

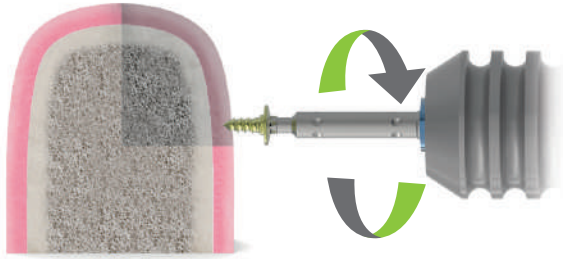
**STEP 5**

On completing the treatment, turn the fixation screw anti-clockwise using the Ziasure ZS2 insertion key and, using tweezers, remove the fixation screw from the surgical area.

NOTE

The time to remove the pin will depend on the type of biomaterial used in the bone regeneration procedure.

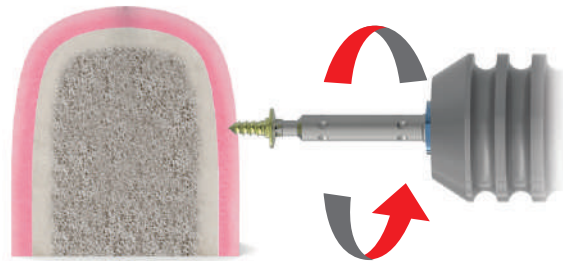
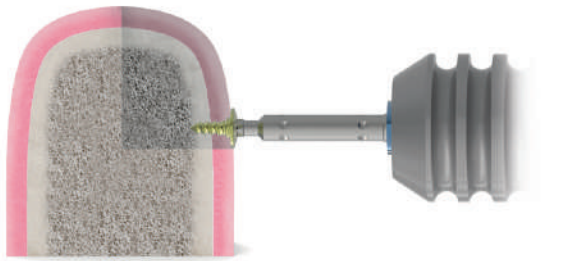
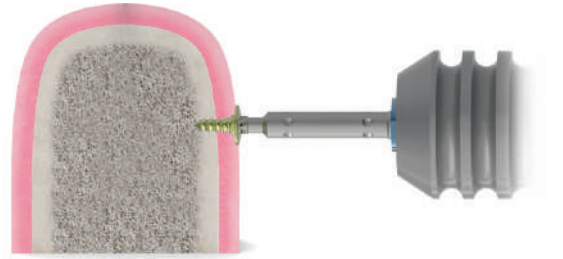



Regenerative

Zs2



Long bone fixation screws



Zs2 long bone fixation screws

Ziacom® Ziasure ZS2 fixation screws are designed to be used in Guided Bone Regeneration (GBR) procedures as devices for securing and immobilisation of bone or soft tissue grafts, resorbable and non-resorbable membranes.

Characteristics

HEAD

- Rounded head: prevents lacerating tissues when fixation screws are placed at an angle.
- Torx connection: facilitates insertion and removal once the treatment is finished.

BODY

- Self-tapping body to facilitate placement and improve stability.
- Diameters of 1.00/1.20/1.50/2.00 mm.
- Lengths of 7/9/11/13/15/17 mm (1).

TIP

- Self-tapping tip: facilitates insertion.

MATERIAL

- Grade 5 ELI titanium (medical grade) Ti 6Al 4V

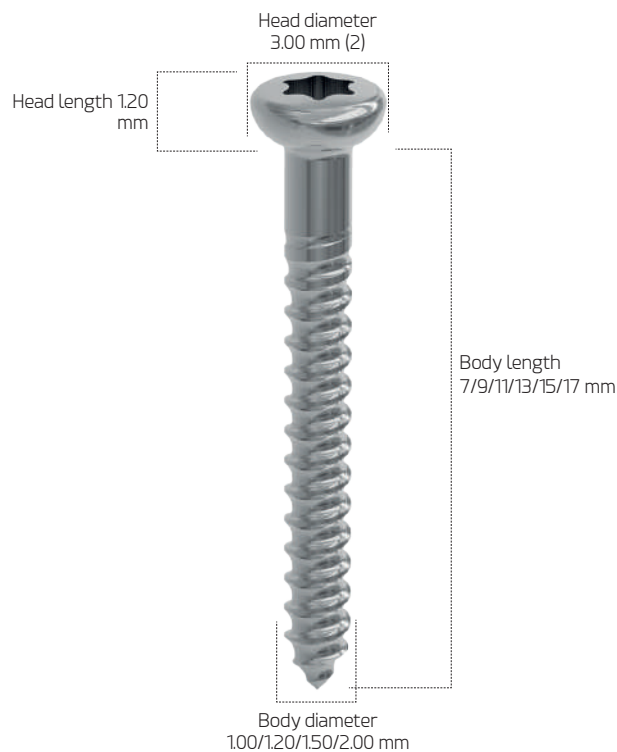

NOTES

(1) Lengths not available in all diameters.

(2) For fixation screws with $\varnothing 1.00$ mm, the head is $\varnothing 2.50$ mm, and for screws with $\varnothing 2.00$ mm, the head is $\varnothing 3.50$ mm.

Recommendations for use

- Provide scaffold with the tenting technique.
- Fixation and immobilisation of grafts in bone regeneration procedures and mucogingival surgery.

NOTE

It is recommended ZS2 fixation screws be removed once treatment has finished. Maximum duration of use is 12 months.

Diameters, lengths and references*

	100 x 7.00	100 x 9.00	100 x 11.00	100 x 13.00	100 x 15.00	120 x 7.00	120 x 9.00	120 x 11.00	120 x 13.00	120 x 15.00	120 x 17.00
DIAMETER	Ø100					Ø120					
LENGTH	7.00	9.00	11.00	13.00	15.00	7.00	9.00	11.00	13.00	15.00	17.00
ANODISED											
REFERENCES 3 UNITS	PS100703*	PS100903*	PS100113*	PS100133*	PS100153*	PS120703*	PS120903*	PS120113*	PS120133*	PS120153*	PS120173*
REFERENCES 5 UNITS	PS100705*	PS100905*	PS100115*	PS100135*	PS100155*	PS120705*	PS120905*	PS120115*	PS120135*	PS120155*	PS120175*

Dimensions in mm.

	150 x 7.00	150 x 9.00	150 x 11.00	150 x 13.00	150 x 15.00	150 x 17.00	2.00 x 7.00	2.00 x 9.00	2.00 x 11.00	2.00 x 13.00	2.00 x 15.00	2.00 x 17.00
DIAMETER	Ø150						Ø2.00					
LENGTH	7.00	9.00	11.00	13.00	15.00	17.00	7.00	9.00	11.00	13.00	15.00	17.00
ANODISED												
REFERENCES 3 UNITS	PS150703*	PS150903*	PS150113*	PS150133*	PS150153*	PS150173*	PS200703*	PS200903*	PS200113*	PS200133*	PS200153*	PS200173*
REFERENCES 5 UNITS	PS150705*	PS150905*	PS150115*	PS150135*	PS150155*	PS150175*	PS200705*	PS200905*	PS200115*	PS200135*	PS200155*	PS200175*

Dimensions in mm.

IMPORTANT

Ziasure ZS2 long fixation screws are supplied unsterilised.

The length and diameter of long fixation screws should be based on the position, technique, type and thickness of the graft.

All references with * ZS2 long fixation screws mentioned on this page are subject to availability.



Zs2 long bone fixation screw

Product presentation

Ziasure ZS2 long bone fixation screws come in a carton sealed with a product label, allowing immediate identification. Each box contains:

- **Ziasure ZS2 long bone fixation screw blister pack:** heat-sealed, with product labels for correct traceability. There is a flap for easy opening in the surgery while preventing accidental opening.
- **Product label information:** product code, diameter and length of the Ziasure ZS2 long bone fixation screws, product description, batch number, manufacturer, date of manufacture and symbols identifying the product.

IMPORTANT

Ziasure ZS2 long bone fixation screws must not be sterilised in their original packaging or with the plastic vial.



Description of the symbology used

- | | | | |
|--|--|--|-----------------------------------|
| | CE marking and notified body number. | | Do not resterilize. |
| | Medical device indicator. | | Do not use if package is damaged. |
| | Product batch number. | | Single-use product. |
| | Patient information website. | | See instructions for use. |
| | Temperature limit. | | Date of manufacture. |
| | Unique device identifier. | | Product manufacturer. |
| | Caution, consult accompanying documents. | | Prescription only. |
| | Non-sterile product. | | |

For full details on the product presentation and instructions for use (IFU), go to www.ziacom.es/ifus or scan the QR code on the box.



Instructions for opening ZS2 long screws

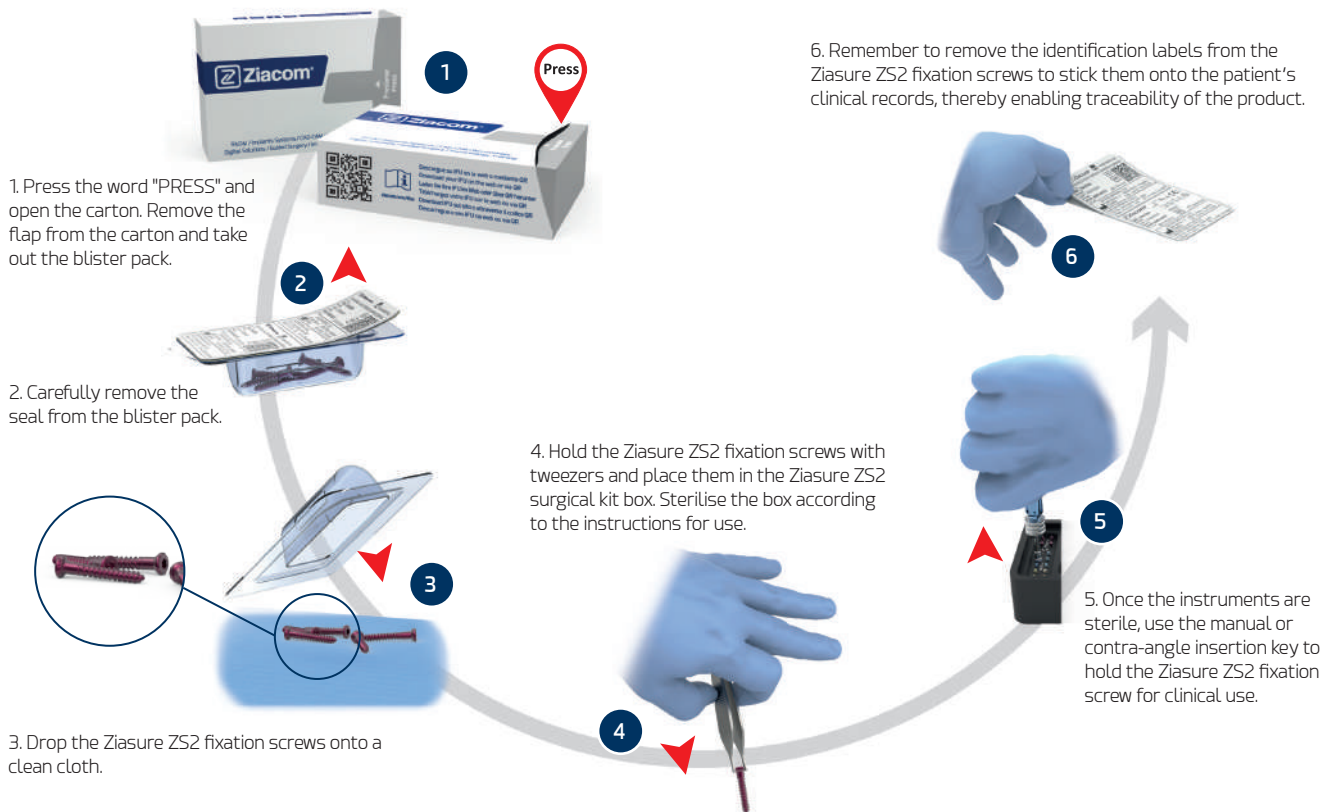

IMPORTANT

Ziasure ZS2 fixation screws are supplied unsterilised.

Zs2 surgical
instruments

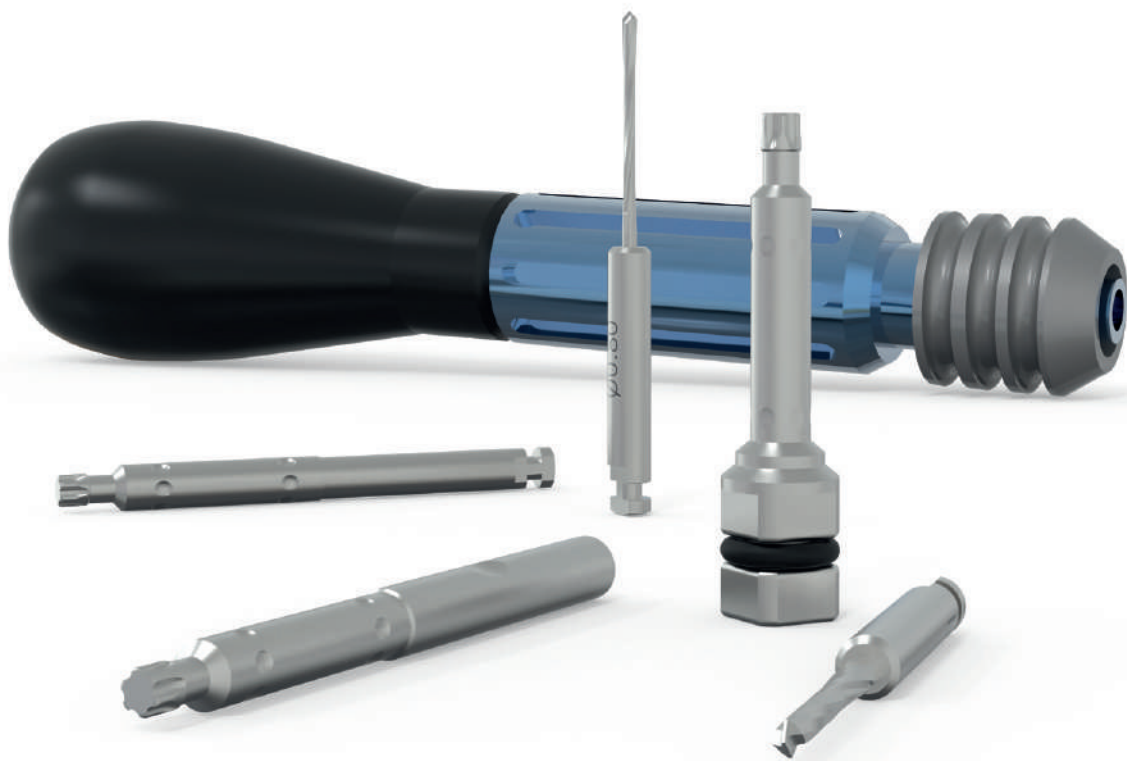

Zs2 surgical instruments

SURGICAL DRILLS

ZS2 surgical drill. CA



Type	Diameter (Ø)	Length (L)	Reference
ZS2	0.80	12.50	OTZS208*
	1.20	12.50	OTZS212*
	1.70	12.50	OTZS217*

References with * OTZS208/OTZS212/OTZS217 (ZS2 surgical drills) are subject to availability.



KEYS

ZS2 insertion key. Manual



Type	Length (L)	Reference
ZS2	14.50	ZS210M

★ Torx connection / ■ Square 4x4 mm



ZS2 insertion key. CA



Type	Length (L)	Reference
ZS2	15.00	ZS220M

★ Torx connection



ZS2 insertion key for driver handle



Type	Length (L)	Reference
ZS2	14.50	ZS300M

★ Torx connection



DRIVER HANDLE

ZS2 driver handle



Type	Length (L)	Reference
ZS2	110.00	MDSQ



Zs2 surgical protocol



Zs2 surgical protocol

It is important to consider that Ziasure ZS2 fixation screws should be placed into alveolar bone and the placement protocol will depend on the fixation required, the position of tooth roots and other anatomical structures.

Steps for placing ZS2 long screws

Ziasure

- EXAMPLE:
ZS2 long
fixation screws
Ø2,00x11,00 mm

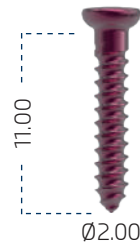

INTRODUCTION | Material required

1. ZS2 surgical drill Ø0.80x12 mm CA (Ref. OTZS208)
2. ZS2 surgical drill Ø1.30x12mm CA (Ref. OTZS212)
3. ZS2 surgical drill Ø1.70x12mm CA (Ref. OTZS217)
4. Ziasure ZS2 insertion key manual (Ref. ZS210M)
5. Ziasure ZS2 insertion key CA (Ref. ZS220M)
6. ZS2 insertion key for driver handle (Ref. ZS300M)
7. ZS2 driver handle (Ref. MDSQ)



STEP 1

After retrieving the graft from the donor area, make it fit the recipient site and then select the site for the fixation screw.



STEP 2

Using the Ziasure ZS2 surgical drill at 700 rpm, make a surgical bed in the graft until the cortical bone of the receiving bed is reached.

NOTE

The diameter of the Ziasure ZS2 surgical drill used will depend on the diameter of the Ziasure ZS2 fixation screw being placed. For the Ziasure ZS2 1.00 and 1.20 mm long screws, use the Ziasure ZS2 0.80 mm surgical drill; for the Ziasure ZS2 1.50 mm long screw, use the Ziasure ZS2 1.20 mm surgical drill; and for the Ziasure ZS2 2.00 mm long screw, use the Ziasure ZS2 1.70 mm surgical drill.



STEP 3

Hold the insertion key handle at its widest point in the palm of your hand and use your index finger and thumb to pull back the ring. Push the Ziasure ZS2 insertion key in until it is correctly seated and let the ring go.

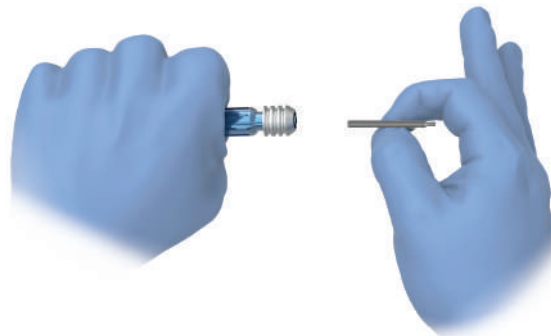

STEP 4

Use the Ziasure ZS2 insertion key with the insertion key handle or the Ziasure ZS2 insertion key for contra-angle to pick up the Ziasure ZS2 long fixation screw and make sure it is sure.

NOTE

Use of more than one Ziasure ZS2 fixation screw is recommended to stabilise the membrane, titanium mesh membrane or graft.



STEP 5

Place the Ziasure ZS2 fixation screw in the surgical bed made with drill and exert firm, controlled pressure to turn the screw clockwise using the Ziasure ZS2 insertion key in the insertion key handle or in the contra-angle, at a rate of 25 rpm, and apply a torque of 15 Ncm or less until one third of the length of the screw is anchored in the recipient area bone. Make sure the head of the screw makes contact with the graft.

NOTE

Use of more than one Ziasure ZS2 long fixation screw is recommended to prevent micro-movements of the graft.

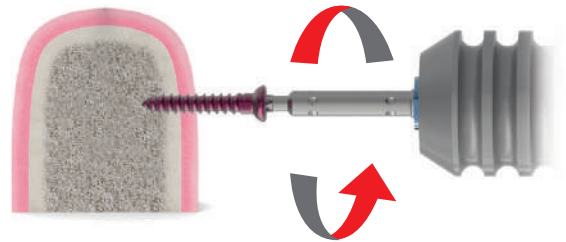
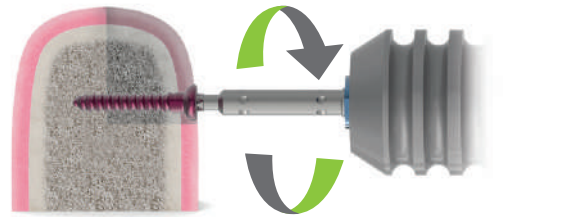



Regenerative

Zs3

Titanium mesh membranes

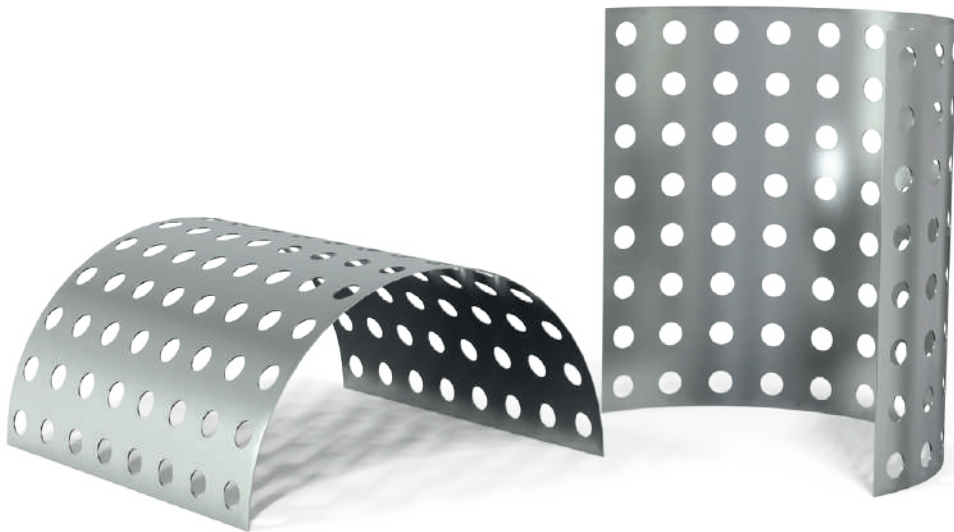

ZS3 titanium mesh membranes

The creation, maintenance and stability of the biomaterial and also the blood clot are the most important aspects for successful Guided Bone Regeneration procedures. However, these may be impossible to achieve by simply using resorbable membranes, especially in large horizontal regenerations or vertical regenerations.

For this type of clinical situation, Ziacom® has created Ziasure ZS3 titanium mesh membranes. Their design means that they can be used as physical barriers in Guided Bone Regeneration procedures, which makes it possible to create and maintain the necessary space for bone formation. It also provides the clot and bone substitute with stability, resulting in predictable Guided Bone Regeneration procedures.

ZS3 titanium mesh membranes

The ZS3 titanium mesh membrane is designed to be used as a physical barrier in Guided Bone Regeneration procedures, especially in vertical and horizontal regenerations. Its design allows it to be easily adjusted to the surgical bed, and also guarantees the stability of the blood clot and bone substitute, achieving excellent clinical results.

■ Characteristics

GENERAL

- Thickness of 0.12 mm.
- Easily malleable: allows the mesh membrane to be shaped according to the clinical condition.
- Physical properties that help maintain the space and make the graft stable for bone regeneration processes.
- Mesh design: improves graft nutrition.
- Anodising treatment: improves mechanical properties and prevents translucency of the mesh membrane in the mucosa.

MATERIAL

- Grade 2 titanium.

References and dimensions

ZS3 titanium mesh membranes

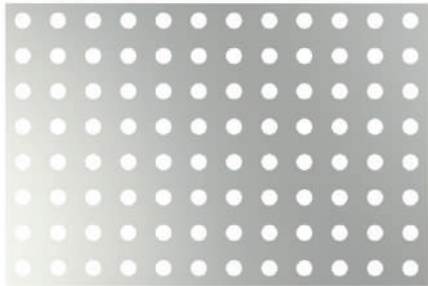
	DIMENSIONS	REFERENCE	MATERIAL
	20x30	ZIM2030*	Grade 2 Titanium
	30x40	ZIM3040*	

Dimensions in mm.

References with * ZIM2030/ZIM3040 (ZS3 titanium mesh membranes) are subject to availability. 

Recommendations for use

Titanium mesh membranes are indicated for:

- Horizontal bone regeneration procedures;
- Vertical bone regeneration procedures;
- Simultaneous bone regeneration and implant placement.

NOTES

- They can be used in combination with resorbable membranes. Use fixation screws to secure and immobilise the mesh membrane.
- It is recommended the titanium mesh membrane be removed once treatment has finished. Maximum duration of use is 12 months.

Consult the references available at www.ziacom.com/biblioteca for more information on the use of titanium mesh membranes.



Instruments

Mesh membrane scissors

	REFERENCE	MATERIAL
	MTQ5*	Stainless Steel

The reference with * MTQ5 (Mesh membrane scissors) is subject to availability.



Regenerative

Zs3 surgical protocol

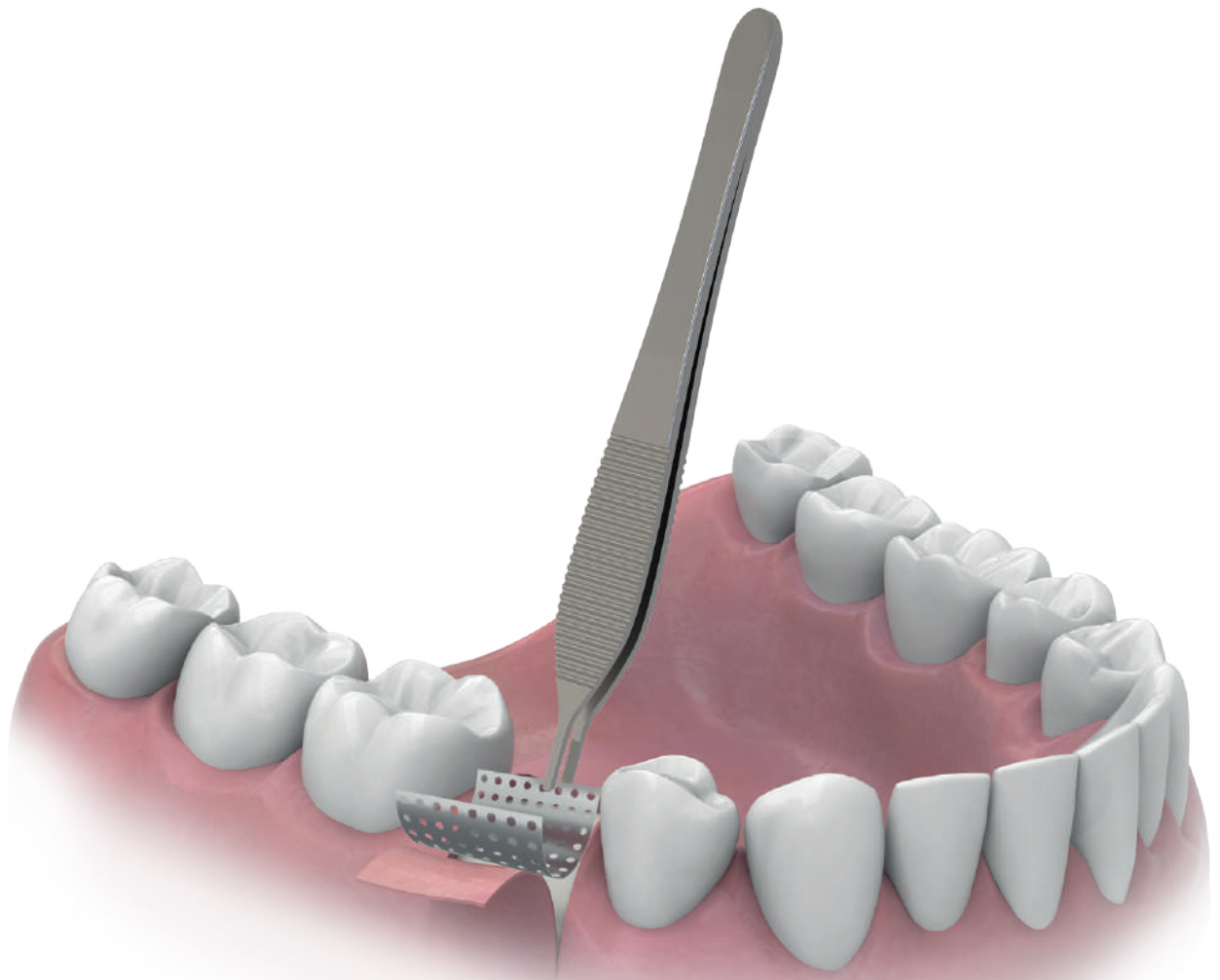

ZS3 surgical protocol

ZS3 titanium mesh membrane protocol

PRELIMINARY STEP

When planning regenerative treatment with titanium mesh membranes, it is necessary to first evaluate the case, taking into consideration the patient's medical history, physical examination and imaging.



STEP 1

Lift a full-thickness flap in the area where the bone regeneration procedure is to be performed, taking particular care when handling soft tissues and nearby anatomical structures.



STEP 2

Cut, shape and trim the mesh membrane to fit the surgical bed, taking into consideration nearby anatomical structures. It is important to make sure no sharp edges are left that could damage the soft tissue.

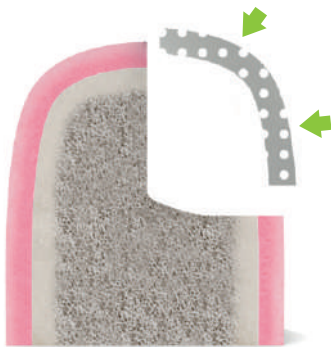

STEP 3

Secure and immobilise one side of the titanium mesh membrane with fixation screws. Place the bone substitute and make sure the biomaterial is well compacted onto the mesh membrane, taking care not to alter its fit in the surgical bed.

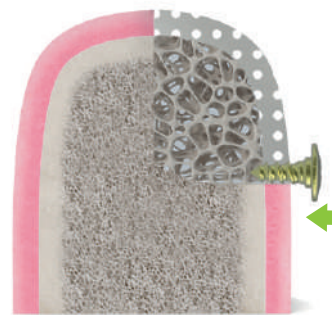

STEP 4

Finish inserting the fixation screws and make sure the titanium (Ti) mesh membrane does not move at all.

NOTE

A resorbable membrane can be used to cover the titanium mesh membrane.

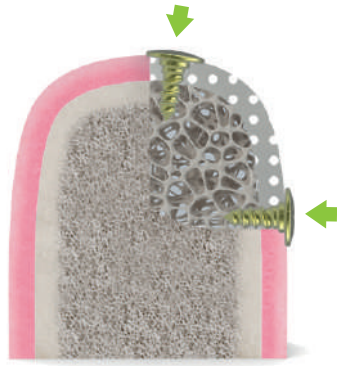

STEP 5

Once the bone regeneration time has elapsed, which will depend on the type of biomaterial used, remove the fixation screws one by one and carefully lift off the titanium mesh membrane.

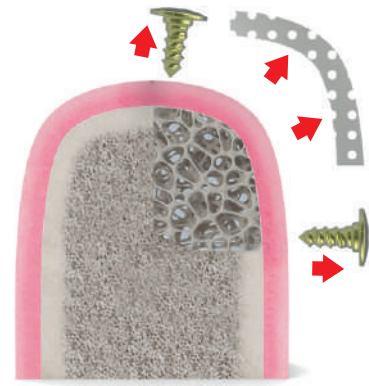



Regenerative

Zs3



Honeycomb titanium mesh membranes

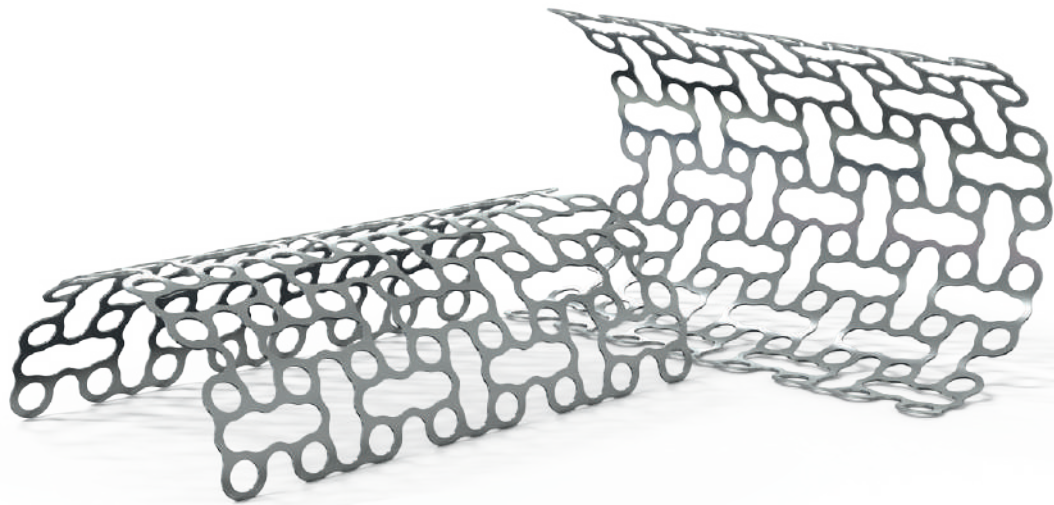

ZS3 titanium mesh membranes

ZS3 honeycomb titanium mesh membranes

The Ziasure ZS3 titanium mesh membrane has an innovative design that allows it to be used as a scaffold in vertical and horizontal bone regeneration procedures.

■ Characteristics

GENERAL



- Thickness of 0.30 mm.
- Honeycomb architecture: improves rigidity.
- Macropores: improve blood irrigation of the graft.
- Anodising treatment: improves mechanical properties and prevents translucency of the mesh membrane in the mucosa.

MATERIAL

- Grade 2 titanium.

References and dimensions

ZS3 honeycomb titanium mesh membranes

	DIMENSIONS	REFERENCE	MATERIAL
	40x40	ZIM4040*	

Dimensions in mm.

References with * ZIM4040 (ZS3 honeycomb titanium mesh membranes) are subject to availability.

Recommendations for use

The honeycomb titanium mesh membrane is used for the cage technique in horizontal and/or vertical bone regeneration procedures. They should always be used in combination with resorbable membranes.

NOTES

- Use fixation screws to secure and immobilise the mesh membrane.
- It is recommended the titanium mesh membrane be removed once treatment has finished. Maximum duration of use is 12 months.

Consult the references available at www.ziacom.com/biblioteca for more information on the use of titanium mesh membranes.



Instruments

Mesh membrane scissors

	REFERENCE	MATERIAL
	MTQ5*	Stainless Steel

i
The reference with * MTQ5 (Mesh membrane scissors) is subject to availability.



Regenerative

Zs3 surgical protocol

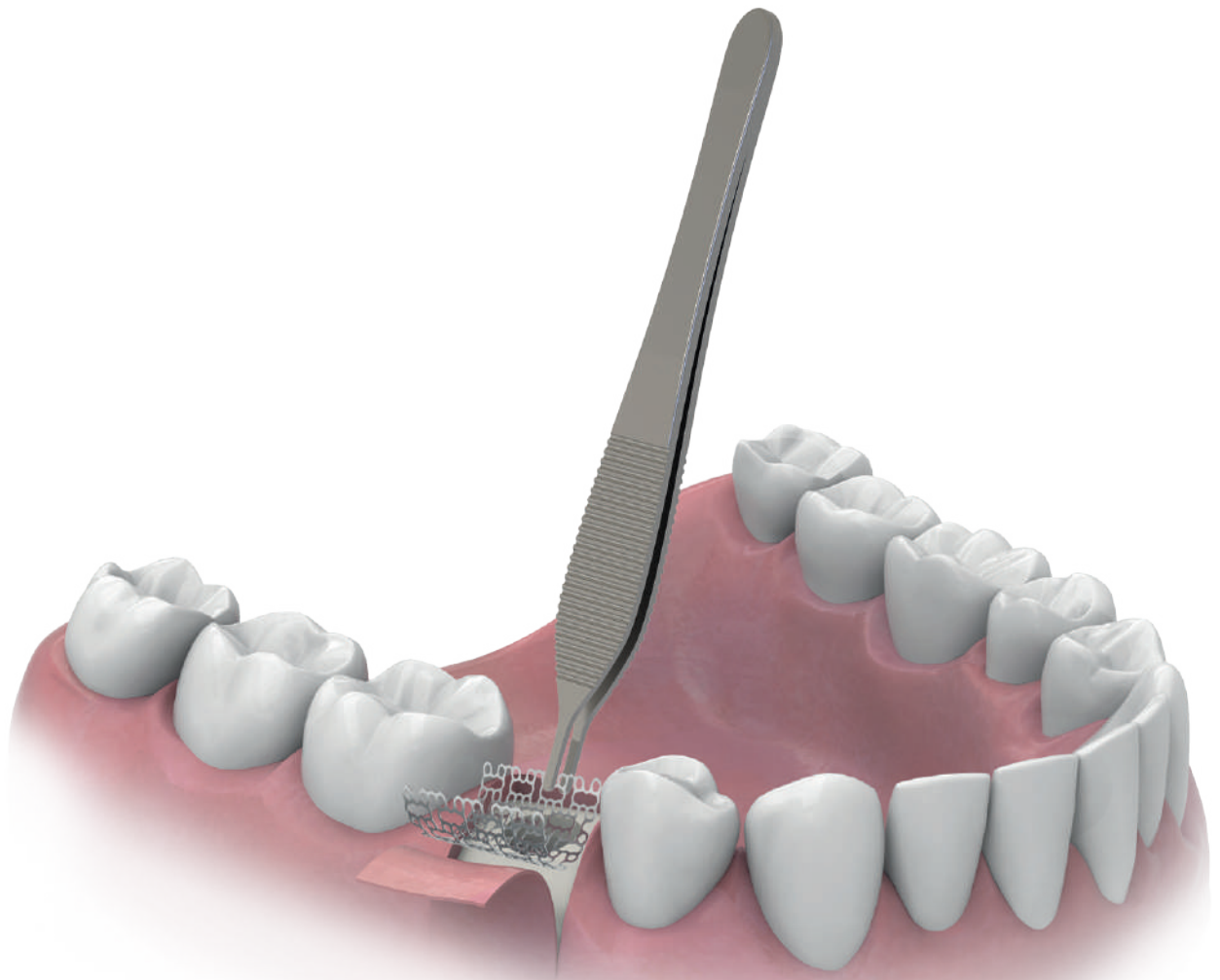

ZS3 surgical protocol

ZS3 honeycomb titanium mesh membrane protocol

PRELIMINARY STEP

When planning regenerative treatment with titanium mesh membranes, it is necessary to first evaluate the case, taking into consideration the patient's medical history, physical examination and imaging.

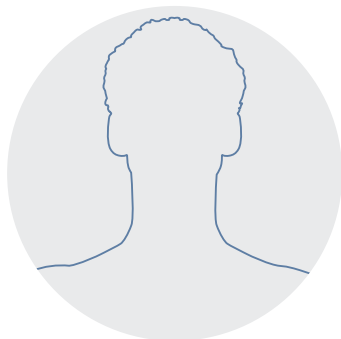

STEP 1

Lift a full-thickness flap in the area where the bone regeneration procedure is to be performed, taking particular care when handling soft tissues and nearby anatomical structures.



STEP 2

Cut, shape and trim the ZS3 mesh membrane to fit the surgical bed by forming a wall (depending on the defect, this may be the vestibular and/or lingual wall), thereby creating a rigid cage that acts as a scaffold for bone regeneration. Make sure the mesh membrane has no sharp edges.

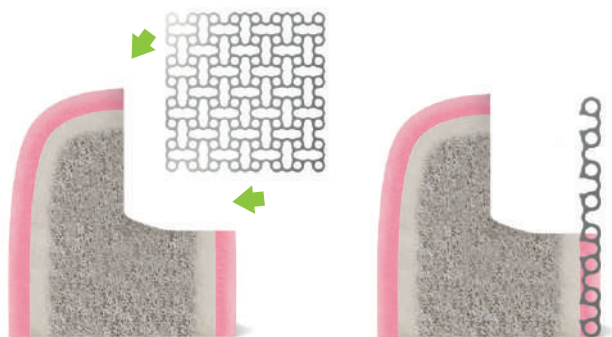

STEP 3

Secure and immobilise the mesh membrane by inserting the fixation screws and make sure the ZS3 mesh membrane does not move at all.

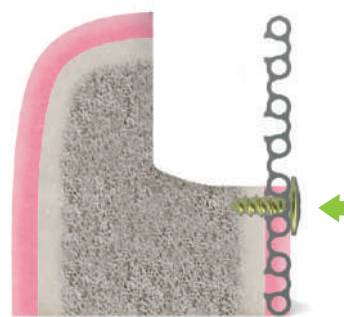

STEP 4

Place the biomaterial on the cage created with the titanium mesh membrane.



STEP 5

Place a resorbable membrane to cover the biomaterial and the titanium mesh membrane.

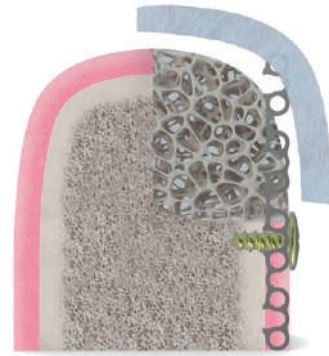

STEP 6

Once the bone remodelling time has elapsed, which will depend on the type of biomaterial used, remove the fixation screws one by one and carefully lift off the titanium mesh membrane.

NOTE

It is recommended the mesh membrane be removed once treatment has finished. Maximum duration of use is 12 months.

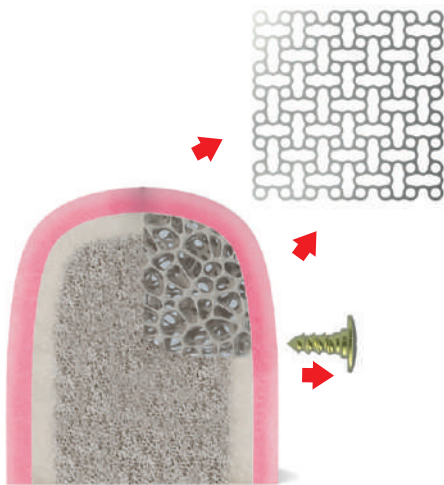



Regenerative

Other
products



Other products

Graduated trephines

Ziacom® graduated trephines are designed to harvest autografts and take bone tissue biopsies, and to remove failed dental implants.

Their reduced wall thickness and DLC (Diamond Like Carbon) coating ensure greater strength and durability with a smaller cutting diameter, allowing more of the bone tissue to be preserved, especially in cases requiring implant removal.

Their apical region has optimised cutting angles that facilitate osteotomies and increase the accuracy of cuts, reducing surgical trauma to the bone. They also have graduations at 2/4/6/8/10 mm, which makes it easier for the surgeon to determine the depth at which he is working.



Kit of 4 graduated trephines
Reference: KTD100

	GRADUATED TREPHINES			
REFERENCE	OFC35	OFC40	OFC45	OFC50
TOTAL DIAMETER (CUTTING RADIUS)	4.35	4.95	5.30	5.90
INTERNAL DIAMETER	3.55	4.15	4.55	5.15







Dimensions in mm.

Expanders

The Ziacom® Expander Kit offers dental clinicians expanders in progressive diameters which can be used consecutively to compress and expand low-density bone and perform split-crest procedures.

The morphology of our laser-marked, differentially designed expanders, in a wide range of shapes, sizes and types, makes the Ziacom® Expander Kit a powerful ally of the dental surgeon.

■ References and dimensions

BONE EXPANDERS							SINUS LIFT BONE EXPANDER
CODE	1	2	3	4	5	6	7
EXPANDER KIT							
REFERENCE	EOX100	EOX200	EOX300	EOX400	EOX500	EOX600	EOX700
END/NECK Ø	2.00	2.35	2.85	3.10	3.40	3.80	3.40
TIP/APEX Ø	1.50	1.80	2.50	2.35	2.50	2.70	2.50
INSTRUMENT LENGTH	23.40	23.40	23.40	23.40	23.40	23.40	23.40
ACTIVE LENGTH	14.50	14.50	14.50	14.50	14.50	14.50	14.50
APEX LENGTH	2.00	2.00	2.00	2.00	2.00	2.00	1.00
TOTAL Ø	2.50	2.85	3.20	3.55	3.90	4.25	4.00
IMPLANT Ø	NO END	NO END	3.30	3.60/3.70	4.00	4.30/4.40	4.00

Dimensions in mm.

NOTE

Bone expanders must be used sequentially according to the insertion protocol.

■ GENERAL FEATURES OF BONE EXPANDERS

- Head compatible with 4x4 mm ratchet.
- 14.5 mm long active section.
- Thread design.
- Optimised shape.
- Laser-marked expander.
- Atraumatic tip.

■ SPECIFIC FEATURES OF SINUS LIFT BONE EXPANDER

- With acute edges to facilitate compression of the cortical bone surrounding the sinus membrane and a concave centre to collect bone tissue, which reduces the risk of sinus membrane perforation.



Regenerative

Cleaning, disinfection and sterilisation

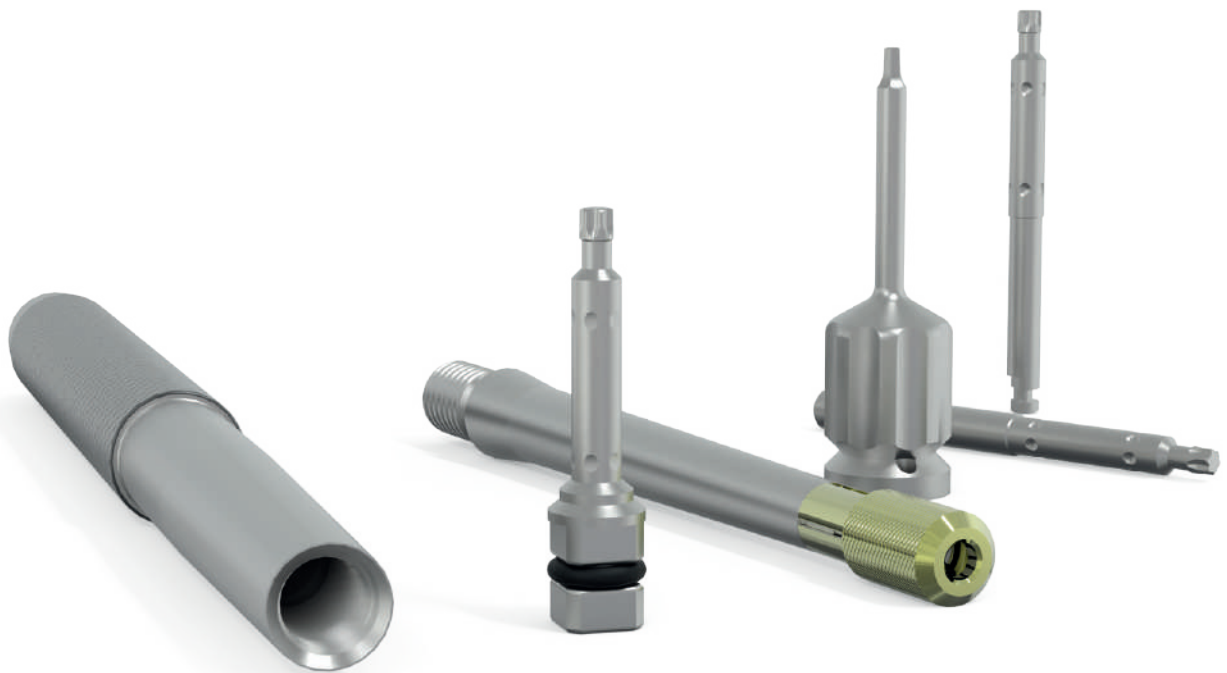

Cleaning, disinfection and sterilisation

The protocols described in this section must only be carried out by personnel qualified to clean, disinfect and sterilise the dental materials specified here in.

Cleaning and disinfection instructions

Applicable for instruments, surgical and prosthetic boxes and plastic retainer caps.

■ Disassembly

1. Dismount* the appropriate instruments, for example manual ratchets, drills or drill stops.
2. Remove the various components from the surgical or prosthetic box for correct cleaning.

■ Cleaning and disinfection

For disinfecting instruments and surgical boxes:

1. Submerge the instruments in a detergent/disinfectant solution** suitable for dental instruments to help eliminate any adhered biological residues. If an ultrasound bath is available***, confirm that the detergent/disinfectant solution is indicated for use with this type of equipment.
2. Manually remove any biological residues with a non-metallic brush and pH-neutral detergent.
3. Rinse with copious water.
4. When cleaning the surgical and prosthetic boxes, always use a pH-neutral detergent and non-abrasive utensils to avoid damaging the surface of the boxes.
5. Dry the materials with disposable cellulose, lint-free clothes or compressed air.

For disinfecting plastic caps and spacers:

1. Submerge in a neat benzalkonium chloride solution for 10 minutes.
2. Rinse with distilled water.
3. Dry the caps and spacer before use.

■ Inspection

1. Check that the instruments are perfectly clean; if not, repeat the cleaning and disinfection steps.
2. Discard any instruments with imperfections and replace them before the next procedure.
3. Check that the instruments and the surgical and prosthetic boxes are perfectly dry before reassembling the parts and proceeding to their sterilisation.

* See the assembly disassembly manuals at www.ziacom.com/biblioteca

** Follow the instructions from the disinfectant's manufacturer to determine the correct concentrations and times.

*** Follow the instructions from the ultrasound bath's manufacturer to determine the correct temperature, concentration and times.

Sterilisation instructions for steam autoclave

Applicable to orthodontic implants, abutments, and surgical and prosthetic instruments and boxes.

1. Introduce each material separately in individual sterilisation bags, then seal the bags. For joint sterilisation, place the instruments in their surgical box, introduce the box into a sterilisation bag and seal the bag.
2. Place the bags to be sterilised in the autoclave.
3. Sterilise in a steam autoclave at 134°C/273°F (max. 137°C/276°F) for 4 min (minimum) and at 2 atm. Torque wrenches must be sterilised in 3 vacuum cycles at 132°C/270°F for a minimum of 1.5 minutes and vacuum-dried for a minimum of 20 minutes.

For the United States only: The validated and recommended sterilisation cycle for the US must be performed in a steam autoclave at 132°C/270°F for at least 15 min and with the drying time of at least 15 - 30 min.

IMPORTANT

Make sure the drying stage is allowed to run to completion, otherwise the products may be damp.

Check the sterilisation equipment if the materials or sterilisation bags are damp at the end of the sterilisation cycle.

Perform the necessary maintenance actions on the autoclave according to the established periodicity and following the manufacturer's instructions.



Storage of Ziacom® products

- Store the products in their original packaging and in a clean, dry location until they are used.
- After sterilisation, keep the products in the sealed sterilisation bags and in a clean, dry location.
- Never exceed the use by date indicated by the manufacturer of the sterilisation bags.
- Always follow the indications of the manufacturer of the sterilisation bags.

General recommendations

- Never use damaged or dirty material; never reuse single-use products. The user is responsible for following the instructions described in this document correctly.
- The attention to piercing or sharp elements. Gloves should be worn when cleaning the materials to avoid accidents during handling.
- Follow the safety instructions indicated by the manufacturer of the disinfectant agent.
- The product's sterility cannot be guaranteed if the sterilisation bag is open, damaged or damp.
- Respect all stages of the sterilisation process. If the materials or sterilisation bags contain traces of water or moisture, check the autoclave and repeat the sterilisation.
- Orthodontic abutments and implants are supplied UNSTERILISED and must always be sterilised before use.
- Instruments and surgical and prosthetic boxes are supplied UNSTERILISED and must always be sterilised before use and cleaned and disinfected after use.
- The sterilisation, cleaning and disinfection processes gradually deteriorate the instruments. Inspect the instruments thoroughly to detect any signs of deterioration.
- Avoid contact between products made from different materials (steel, titanium, etc.) during the cleaning, disinfection and sterilisation processes.
- Ziacom Medical SL recommends these instructions are implemented for the correct maintenance and safety of their products; accordingly, the company refuses any liability for any damage to the products that could arise if the user applies alternative cleaning, disinfection and sterilisation procedures.

See www.ziacom.com/biblioteca for the latest version of the cleaning, disinfection and sterilisation instructions.





See the latest version of the general conditions of sale on our website www.ziacom.com.

Check the availability of each product in your country.

All rights reserved. No part of this document may be reproduced or stored in any medium or reproduction system, nor transmitted in any way or under any concept, electronically, mechanically, in photocopies, recording or any other mean not considered here without the permission of holder of the copyright, editing and printing. Ziacom® is a registered trademark of Ziacom Medical SL.

See the latest version of the catalogues available at www.ziacom.com.

EN | ENGLISH



www.ziacom.com

Ziacom Medical SL

Calle Búhos, 2
28320 Pinto - Madrid - ESPAÑA
Tfno.: +34 91 723 33 06
info@ziacom.com

Ziacom Medical Portugal Lda

Av. Miguel Bombarda, 36 - 5° B
1050 -165 - Lisboa - PORTUGAL
Tel: +351 215 850 209
info.pt@ziacom.com

Ziacom Medical USA LLC

333 S.E 2nd Avenue, Suite 2000
Miami, FL 33131 - USA
Phone: +1 (786) 224 - 0089
info.usa@ziacom.com