

ZMK - ZMR

Special connection onepiece implants



ZMK · ZMR

Special connection onepiece implants



Important information

Please read carefully before using Ziacom® products

General information

This document contains basic information on the use of original Ziacom® dental implant systems, hereafter referred to as Ziacom® dental implants or simply Ziacom® products. This document has been created as quick guide for clinicians responsible for treatment, hereafter the "user", and, therefore, is neither an alternative nor a substitute for specialized training or professional clinical experience.

Ziacom® products must be used according to a suitable treatment plan and adhering strictly to the surgical and prosthetic protocols established by the manufacturer. Read the product-specific surgical and prosthetic protocols as well as the instructions for use and maintenance before using each Ziacom® product. You can find this information on our website, www.ziacom.com, or request it from your nearest authorised Ziacom® distributor.

Liability, safety and guarantee.

The instructions for the use and handling of Ziacom® products are based on internationally published literature, current clinical standards and our clinical experience, so they should be understood as general guiding information. The handling and use of Ziacom® products is the sole responsibility of the user as it is outside the control of Ziacom Medical SL. Ziacom Medical SL, their affiliates and/or their authorised distributors disclaim all responsibility, whether explicit or implicit, total or partial, for possible damage or injury caused by poor handling of the product or any other situation not considered in their protocols and manuals for the correct use of their products.

The user must ensure that the Ziacom® product is appropriate for the intended procedure and end purpose. Neither these instructions for use nor the work or handling protocols for the products release the user from this obligation. Ziacom® products must be used, handled and applied by professionals with the appropriate training and qualifications required according to current legislation in each country.

The total or partial use, handling and/or application of Ziacom® products at any stage of their implementation by personnel who are unqualified or lack the necessary training will automatically void any type of warranty and may cause severe damage to the patient's health.

Ziacom® products are part of their own system, with their own design characteristics and work protocols, including dental implants, abutments or prosthetic components and surgical or prosthetic instruments. The use of Ziacom® products in combination with elements or components from other manufacturers could result in treatment failure, damage to tissues or bone structures, inadequate aesthetic outcomes and severe damage to the patient's health. Therefore, only original Ziacom® products should be used.

The clinician in charge of the treatment is solely responsible for ensuring the use of original Ziacom® products and that they are used according to the corresponding instructions for use and handling protocols throughout the implant procedure. The use of any other non-original Ziacom® components, instruments or products, whether alone or in combination with any original Ziacom® products, will immediately void the warranty of the original Ziacom® products.

See the Ziacom Medical SL Warranty Programme (available on the website or by contacting Ziacom Medical SL, their affiliates or authorised distributors).

Warning. Not all Ziacom® products are available in all countries. Check availability in your country.

The Ziacom® brand and the names of other products and services, including their logos, that are mentioned in this document or on the website www.ziacom.com, are registered trademarks of Ziacom Medical S.L.

Ziacom Medical S.L. reserves the right to modify, change, remove or update any of the products, prices or technical specifications referenced on this website or in any of its documents without prior notification. All rights reserved. The reproduction of this document, whole or in part and in any medium or format, without the corresponding written authorisation from Ziacom Medical SL is prohibited.





Index

The Company	06
Together for health	06
Ziacom® quality	06
Zitium® titanium	06
Investment in innovation and training	07
Ziacom® around the world	07
- Regional headquarter	07
- Subsidiaries	07

ZMK · ZMR special connection onepiece implants

ZMK · ZMR · ZMRS implants	08
ZMK characteristics	08
ZMK diameters and lengths	08
ZMR · ZMRS characteristics	09
ZMR · ZMRS diameters and lengths	09
Surface treatments	10
- Titansure surface treatment	10
Product presentation	12
Insert steps	13
ZMK · ZMR · ZMRS references	14
ZMK recommendations for use	15
ZMR · ZMRS recommendations for use	16
How to use this catalogue	17
Product sheet	17
Symbology	17
Abutments Direct-to-implant restorations	20
Surgical instruments	24
Prosthetic instruments	30
Simplified surgical protocol	34
Cleaning, disinfection and sterilisation	40

The Company

Together for health

Ziacom® has been working for more than 20 years to improve the **oral health** and well-being of patients around the world by **designing and manufacturing innovative**, high-quality dental implant, prosthetic component, surgical instrument and biomaterial solutions.

The company was founded in 2004 with **100% Spanish capital** and began its activity as a manufacturer of dental implants and abutments for several European companies before launching its own **brand of implant systems** in 2006.

In 2015, Ziacom® introduced its **diversification strategy** with the development of **new business lines** and new product lines and the launch of a **new portfolio**, which helped the company achieve a **15% share of the Spanish market** in 2016 with the sale of more than 230.000 implants.

In 2022, the company started up on an **ambitious growth plan** with new goals of **international expansion**, broadening and **diversification** of its portfolio of **products and services** and a Corporate Identity restyle.

Ziacom® quality

Commitment to **quality and innovation** has been part of the values and the essence of Ziacom® since the beginning.

The reason why we used state-of-the-art technology in **every stage of our products' production cycle**, from **design and manufacture to quality assurance, cleaning and packaging**. All of our products are also manufactured using only **high-quality raw materials** after applying **strict controls to select** our main suppliers.

Ziacom Medical SL is a **licensed manufacturer of medical devices** and an AEMPS (Spanish Agency for Medicines and Medical Devices) 6425-PS **marketing authorisation holder**. Our **quality management system**

is **certified** in accordance with the requirements of ISO standards 9001:2015 and 13485:2018, and is also GMP 21 CFR 820 compliant.



Thanks to our ceaseless endeavours to offer our clients an unsurpassable quality, all our implants have a **lifetime guarantee**.

See the General Conditions for Accessing the Guarantee for Ziacom® products.

Zitium® titanium

Ziacom® **ZMK · ZMR** implants are manufactured using **extra-high-strength grade 4 Zitium® titanium** which gives them **considerably improved yield strength and mechanical properties**.

Thanks to **Zitium® titanium**, our implants meet the requirements of ASTM F67 and ISO 5832-3 and are certified in accordance with Council Directive 93/42/EEC and its amendment Directive 2007/47/EC by notified body 0051.

Properties of Zitium® titanium

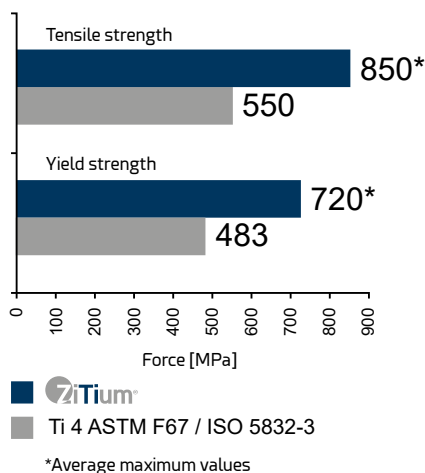

FDA Approved*

*See approved models

Ziacom® implants are all sterilised using beta ray radiation at 25 kGy, apart from the DSQ orthodontic implants, which are supplied **unsterilised**.

IMPORTANT

All the products (except dental implants) listed in this Ziacom® catalogue are supplied unsterilised and must be sterilised before use.



Investment in innovation and training

In order to always offer the very best solutions for the **well-being of every patient**, and thanks to the experience and dedication of our **highly-qualified professionals** and **innovative Technological Centre**, our R&D&I team works incessantly in the field of **research and innovation** to **improve** our products and develop **new solutions** to meet the demands and needs of both patients and dentists.

We also invest in **research** and **ongoing training** as a way of providing **scientific support to the sector** and we firmly believe in training **young professionals** to ensure the best **advances in dentistry field**.

We therefore work closely with **training centres, universities and scientific bodies** to create a practical and specialised teaching environment to promote and strengthen their knowledge, abilities and professional growth.

In order to enhance our investment in the training and **development of dental professionals**, we have **specific areas at our facilities** for **hands-on training and practicals, state-of-the-art** training equipment and also a **physical and virtual showroom** where professionals can see all our dental solutions first hand.

Ziacom® around the world

We are committed to making oral health available to patients all over the world and have a solid **internal growth and expansion plan** to increase the company's **international presence** in those **areas where we our products are already available** and to add **new growth areas**.

In order to achieve this, we offer our **international associates** a **trusting and collaborative** partnership by adapting to their **local needs** and providing solutions that are specific to each market.

As part of our commitment to meet the specific **quality, regulatory and legal requirements of each country**, for both the registration and distribution of our products, we have **specific certifications** from each of the countries in which we trade.

Regional headquarter

Ziacom Medical SL

Madrid - ESPAÑA
Calle Búhos, 2 - 28320 Pinto
Tel: +34 91 723 33 06
info@ziacom.com

Subsidiaries

Ziacom Medical Portugal Lda

Av. Miguel Bombarda, 36 - 5º B
1050 -165 - Lisboa - PORTUGAL
Tel: +351 215 850 209
info.pt@ziacom.com

Ziacom Medical USA LLC

Miami - EEUU
333 S.E 2nd Avenue, Suite 2000
Miami, FL 33131 - USA
Phone: +1(786) 224 - 0089
info.usa@ziacom.com

Please see the up-to-date list of Ziacom® distributors at www.ziacom.com or email us at export@ziacom.com



ZMK characteristics

SURGICAL PHASE

- Minimally invasive surgery: simplifies drilling protocol and reduces surgical time.
- Single surgical phase, transmucosal: surgical simplicity and mostly asymptomatic postoperative.
- Non second surgery needed: shorter tissue healing time.
- Reduced diameter: allows implant placement in reduced M-D spaces.

PROSTHETIC SIMPLICITY

- Kirator abutment included.
- No abutment screws: non loosening or deterioration due to micro-movements.
- Overdentures: reduction of costs by including abutment (processing pack not included).



Image of a clinical case for rehabilitation with bimaxillary muco-supported implant-retained overdenture

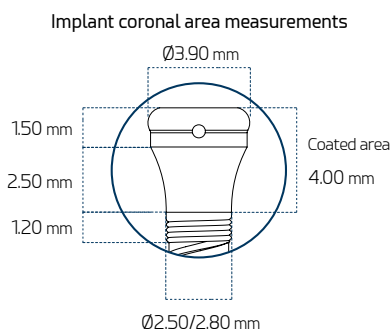
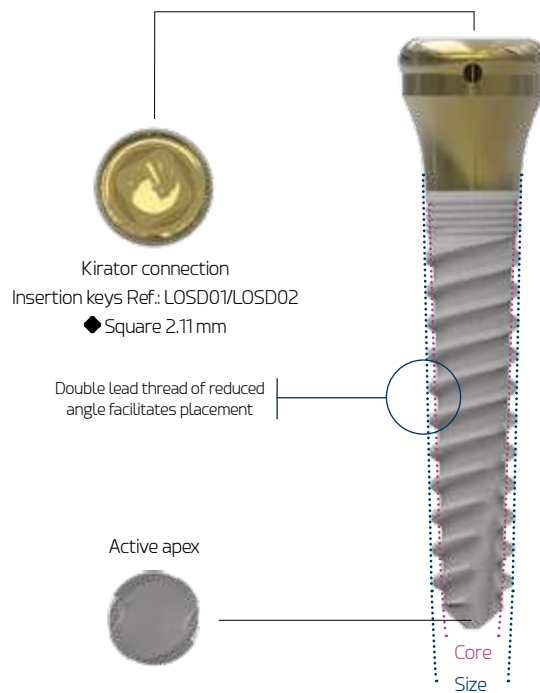

ZMK diameters and lengths

Ø DIAMETER	Ø PLATFORM	LENGTH (L)		
		10	11.5	13
▲ RP 2.50	3.90			
▲ RP 2.80				

Dimensions in mm.

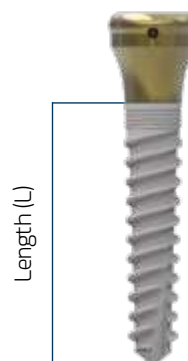

ZMR · ZMRS characteristics

SURGICAL PHASE

- Minimally invasive surgery: simplifies drilling protocol and reduces surgical time.
- Single surgical phase, transmucosal: surgical simplicity and mostly asymptomatic postoperative.
- Non second surgery needed: shorter tissue healing time .
- Reduced diameter: allows implant placement in reduced M-D spaces.

PROSTHETIC SIMPLICITY

- Sculptable straight abutment: makes impression easy. Immediate function.
- No abutment screws: non loosening or deterioration due to micro-movements.

TWO TYPES

- Non surface treatment models as a traditional implant for provisional immediate loading are available (only in Ø2.5mm)

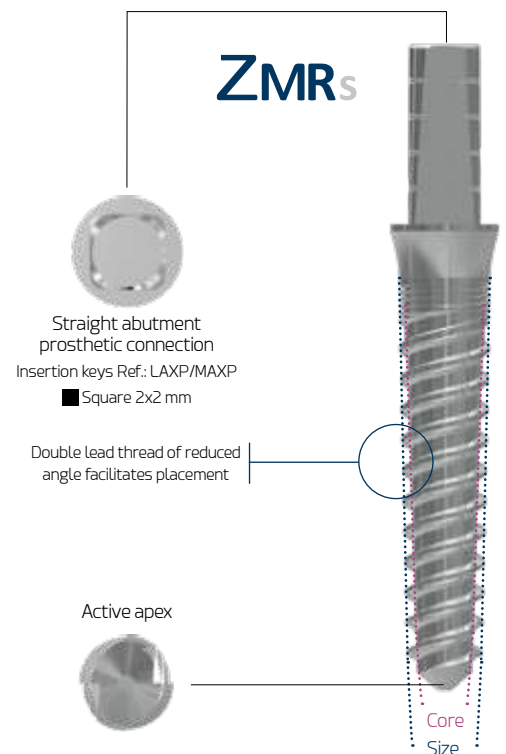
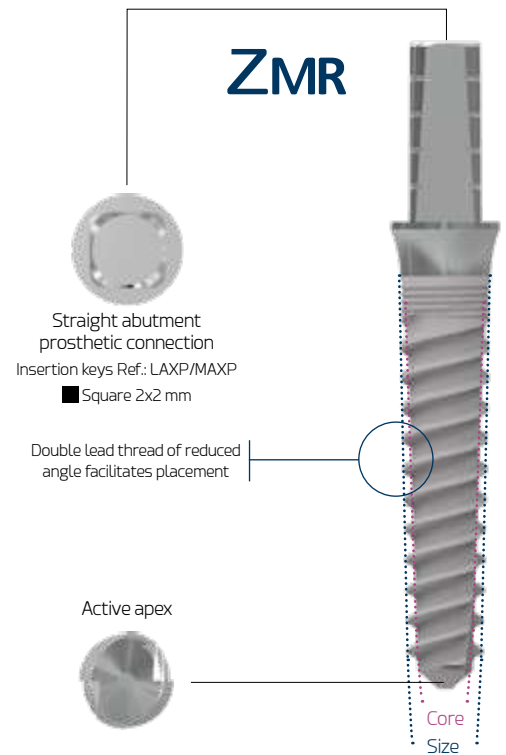
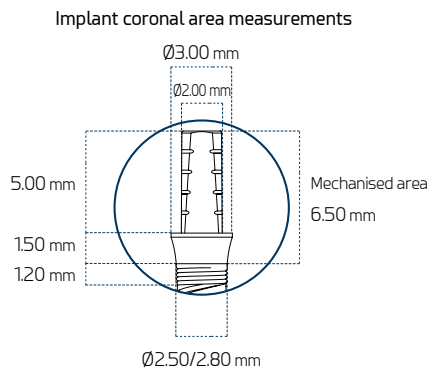

ZMR · ZMRS diameters and lengths

Ø DIAMETER	Ø PLATFORM	LENGTH (L)		
		10	11.5	13
▲ RP 2.50	3.00			
▲ RP 2.80				

Dimensions in mm.

Surface treatments

■ Titansure surface

Implants inserted following surface treatment are known to benefit from improved osseointegration by increasing the bone-to-implant contact area. This is partly due to the implant's chemical composition and topographical characteristics.

With our **Titansure** surface treatment, at Ziacom Medical we have obtained a contaminant-free surface topography and optimal average macro- and microporosity values, which are key specifications for achieving prompt and proper osseointegration and, in turn, extremely reliable and predictable implants.

■ TITANSURE SURFACE ANALYSIS

Titansure is an SLA surface treatment created through a subtraction process involving sandblasting with white aluminium oxide and double acid etching with hydrofluoric acid and a sulphuric/phosphoric acid mix.

Surface morphology analysis

With the aid of a scanning electron microscope (FEI TENE0, Thermo Fisher Scientific Inc., Waltham, MA, USA), we can see the rough, porous surface creating numerous cavities with thin, sharp edges.

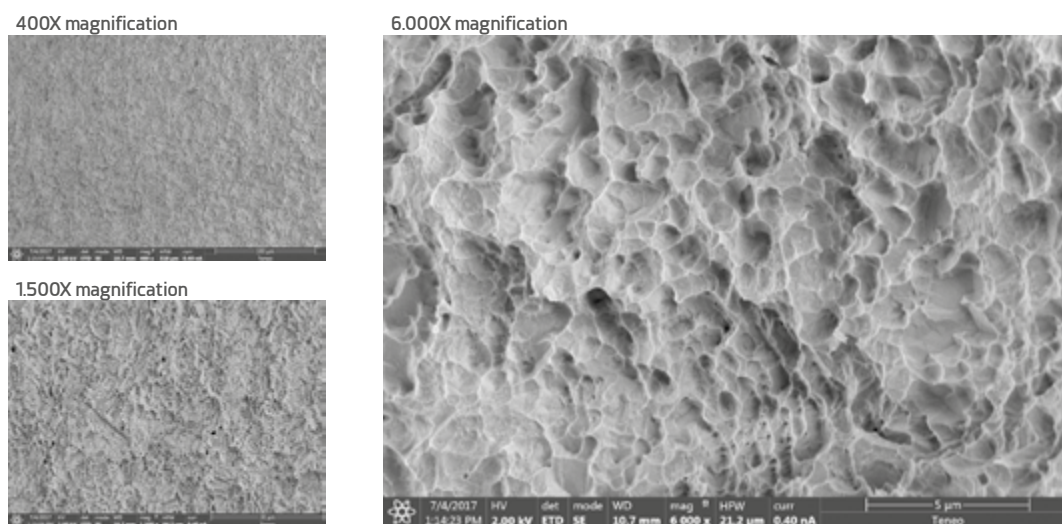

Surface elemental analysis

We used an energy-dispersive X-ray spectrometer (Octane Super, Edax-Ametek, Mahwah, NJ, USA) to analyse the chemical composition at the surface.

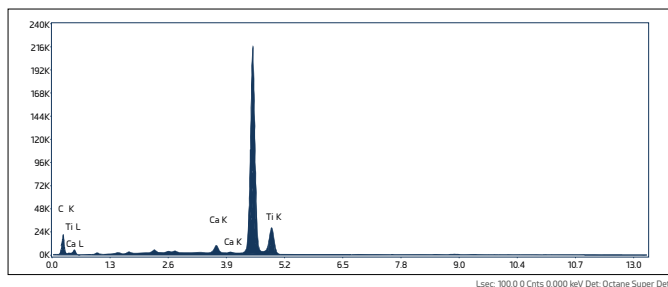

Compositional analysis of implant surface

ELEMENT	WEIGHT (%)
C K	9.32 (10.23)
Al K	-
Ti K	89.53 (11.77)

No aluminum was detected

Results are expressed as the mean and standard deviation of the mass percentage (WEIGHT (%)).

Surface roughness analysis

The roughness study was conducted with a Sensofar S NEOX interferometric-confocal microscope (Sensofar Medical, Terrasa, Spain) and SensoMAP Premium 7.4 software. The quantitative roughness profile parameters applied were: average roughness (Ra), root-mean-square roughness (Rq), maximum profile peak height roughness (Rp) and maximum profile valley depth roughness (Rv).

Ra (µm) (SD)	Rq (µm) (SD)	Rp (µm) (SD)	Rv (µm) (SD)
0.82 (0.10)	0.97 (0.08)	1.84 (0.04)	2.21 (0.01)

The 3D surface roughness (Sa), 3D root mean square height (Sq), maximum 3D peak height (Sp) and maximum 3D pit depth of the selected area (Sv) were also recorded.

Sa (µm) (SD)	Sq (µm) (SD)	Sp (µm) (SD)	Sv (µm) (SD)
0.76 (0.01)	0.97 (0.01)	4.20 (0.12)	4.62 (0.20)

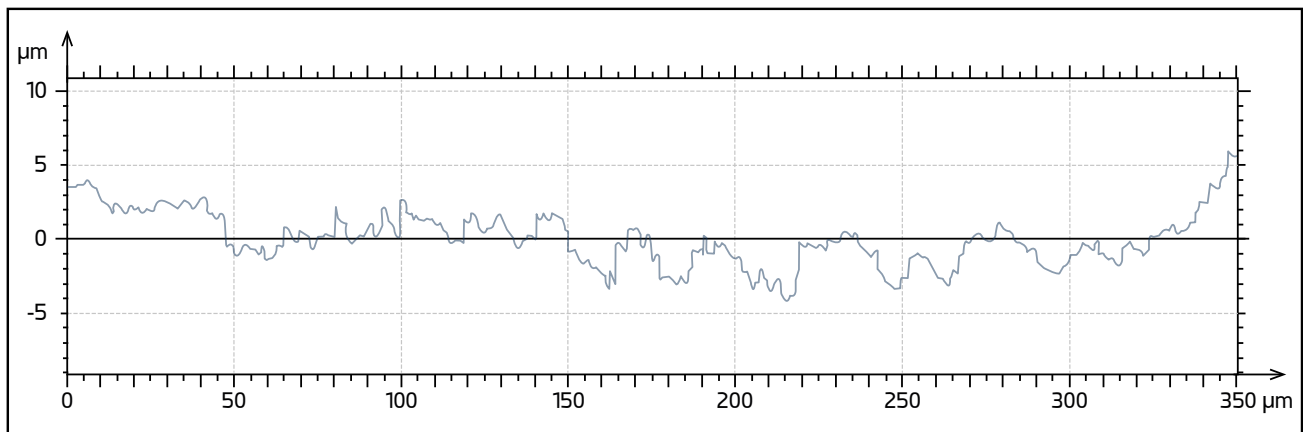

The data were extracted from:

Rizo-Gorrita, M.; Fernandez-Asian, I.; Garcia-de-Frenza, A.; Vazquez-Pachon, C.; Serrera-Figallo, M.; Torres-Lagares, D.; Gutierrez-Perez, J. Influence of Three Dental Implant Surfaces on Cell Viability and Bone Behavior. An In Vitro and a Histometric Study in a Rabbit Model. *Appl. Sci.* 2020. 10(14), 4790

■ OPTIMAL OSSEOINTEGRATION

The **Titansure** surface has a three-dimensional surface structure with high peaks and broad troughs, which is known to be highly effective at promoting the coagulation cascade and the release of growth factors through platelet activation [Kim, H.; Choi, S.H.; Ryu, J.J.; Koh, S.Y.; Park, J.H.; Lee, I.S. The biocompatibility of SLA-treated titanium implants. *Biomed. Mater.* 2008. 3. 025011].

This type of surface may have an osteogenic effect thanks to its different topographical features at a micrometer and nanometer level, which has a very similar morphology to the osteoclastic bone resorption cavities [Le Guehennec, L.; Goyenvalle, E.; Lopez-Heredia, M.A.; Weiss, P.; Amouriq, Y.; Layrolle, P. Histomorphometric analysis of the osseointegration of four different implant surfaces in the femoral epiphyses of rabbits. *Clin. Oral Implants Res.* 2008. 19. 1103–1110].

For more information on the surface treatment see the literature available at www.ziacom.com/biblioteca





ZMK · ZMR · ZMRs implants

Product presentation

■ Blister packaging

Available for implants with **Titansure** surface treatment. Blister packs are heat sealed and include product labels in order to be able to trace products correctly and a flap for easy opening in the clinic but while preventing accidental opening.



Titansure

IMPORTANT

Do not open the sterile container until just before inserting the implant.

■ Outer identification label

Ziacom® implants are supplied in a sealed cardboard box that includes a product identification label with a description of their main characteristics.

CE 0051
Rx Only
RP
Ziacom®
MD ZMK2811
LOT Z0000000
Unid **RP** Ø2,80X11,5Mm
Kirator®
STERILE 11
TT ZMK®
TT 2,80X11,5mm
STERILE 11
www.ziacom.com
UDI
(01)08435481202605(17)000000(11)000000(10)Z0000000
Ziacom Medical, SI
Calle Balmes, 2 28020 Pinto - Madrid
España
Tel: +34 91 723 33 06
Ziacom Medical USA, LLC
350 St. Charles Ave. Suite 2000
Miami, FL 33136 USA
Tel: +1 (786) 244-0089

Description of the symbology used

- CE** MDD CE certification and notified body
- MD** Name of the medical device
- LOT** Number of product batch
- UDI** Unique device identification
- STERILE** Sterilised using radiation
- TT** Temperature restriction
- ⚠** Caution, consult accompanying documents
- ⊘** Do not sterilise
- ⊘** Do not use if the packaging is damaged
- ⊘** Non-reusable product
- ℹ** Consult the instructions for use
- 🕒** Expiry date of the product
- 📅** Date of manufacture
- 🏭** Product manufacturer
- TT** Titansure surface treatment
- TTA** Titansure Active surface treatment
- Rx Only** Prescription only

For full details on the product presentation and instructions for use (IFU) see www.ziacom.com/ifu or scan the QR code on the box.



■ Plastic Mount

The packaging option of the one-piece implant with a plastic mount allows a comfortable and quick manual insertion of the implant in the surgical site.

Its advantages include:

- Convenient initial insertion in the implant site.
- Higher retention area for manual use.
- Higher length: facilitates its use with adjacent teeth.
- Higher resistance to torsion.

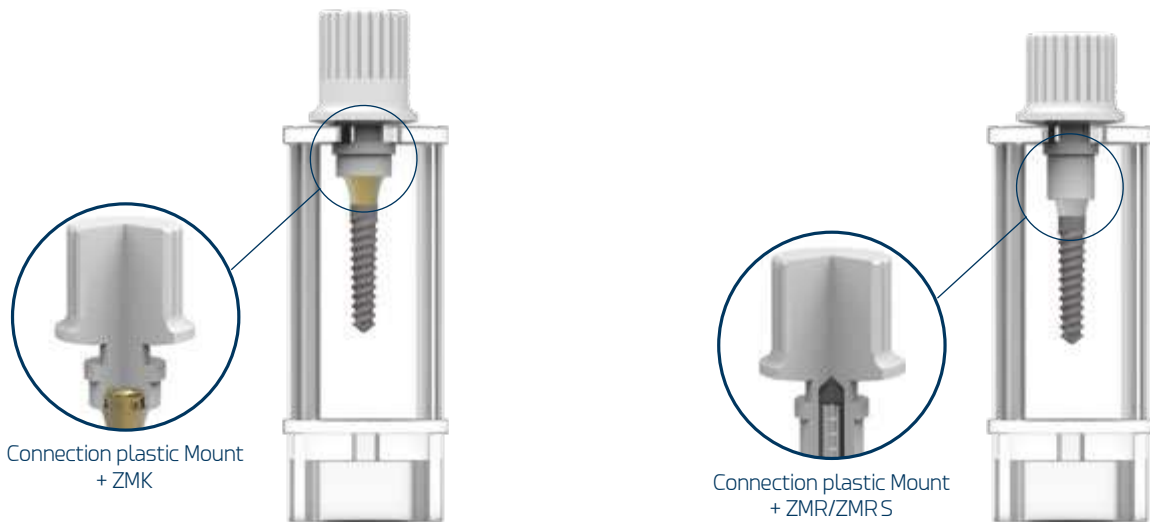

Insert steps

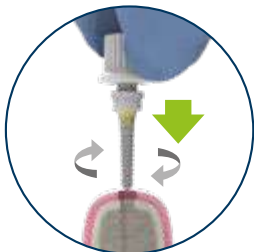

Step 1: insert the implant manually by turning clockwise

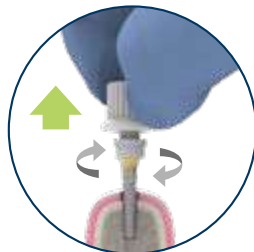

Step 2: separate the plastic Mount at the same time as you perform the insertion

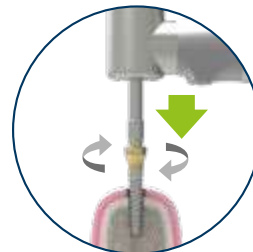

Step 3A: final implant position with CA (Ref. LOSD02)

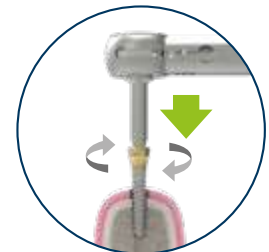



Step 3B: final implant position with ratchet (Ref. LOSD01)



For more information on the use of surgical instruments, see the "Surgical protocol" section on pages 36 to 40 of this catalogue.



ZMK · ZMR · ZMRs implants

ZMK · ZMR · ZMRs references

IMPLANT					
	Ø (mm)	Ø Core (mm)	Length	Ref. Titansure	
ZMK	2.50	2.10/1.50	10.0 mm	ZMK2510	
			11.5 mm	ZMK2511	
			13.0 mm	ZMK2513	
	2.80	2.40/1.75	10.0 mm	ZMK2810	
			11.5 mm	ZMK2811	
			13.0 mm	ZMK2813	

IMPLANT					
	Ø (mm)	Ø Core (mm)	Length	Ref. Titansure	
ZMR	2.50	2.10/1.50	10.0 mm	ZMR2510	
			11.5 mm	ZMR2511	
			13.0 mm	ZMR2513	
	2.80	2.40/1.75	10.0 mm	ZMR2810	
			11.5 mm	ZMR2811	
			13.0 mm	ZMR2813	

IMPLANT					
	Ø (mm)	Ø Core (mm)	Length	References	
ZMRs	2.50	2.10/1.50	10.0 mm	ZMR2510S	
			11.5 mm	ZMR2511S	
			13.0 mm	ZMR2513S	

ZMR

Recommendations for use

All implant planning must respect the natural biomechanical stability of the oral cavity and allow natural emergence of the dental crown through the soft tissue by means of an implant with a prosthetic platform that has a diameter that is proportionally smaller than the emergence diameter of the tooth to be restored. The implantologist must assess the quantity and quality of bone currently in the implant area and consider the need for prior or simultaneous bone regeneration, as appropriate.

Ziacom® has a wide range of implants available to cover every reconstruction possibility. The triangles identified with letters on the periodontal chart represent the implant diameters and platforms recommended for those tooth positions. These recommendations are valid for replacing teeth with single-unit restorations, bridges or partial or complete implant-retained, tissue-supported dentures.

Remember to maintain minimum distances between adjacent implants and between implants and teeth in order to preserve interdental papilla, bone vascularisation and natural emergence profiles.

Selection of the appropriate implant for each case is the sole responsibility of the implantologist. Ziacom Medical advises all clinicians to take into account the warnings based on scientific evidence which can be found in the product catalogues and our website.

■ CLARIFICATIONS ON DRILLING MEASUREMENTS AND TECHNIQUES

- **IMPLANT SIZE:** identifies the diameter and length of the implant.
- **IMPLANT BODY:** diameter of the implant core.
- **DRILL SIZE:** diameter of the drill.
- **DRILLING TECHNIQUE:** we have developed various drilling protocols to enable you to deal with different situations that arise in a schematic way when performing implant surgery.

For more information on implant size selection see the literature available at www.ziacom.com/biblioteca



Periodontal chart

ZMK

Implant diameter⁽¹⁾

▲ RP ▲ RP
 Ø2.50 mm Ø2.80 mm

(1) Diameters available for analogue platforms

Implant crown diameter

▲ RP ▲ RP
 Ø2.50 mm Ø2.80 mm

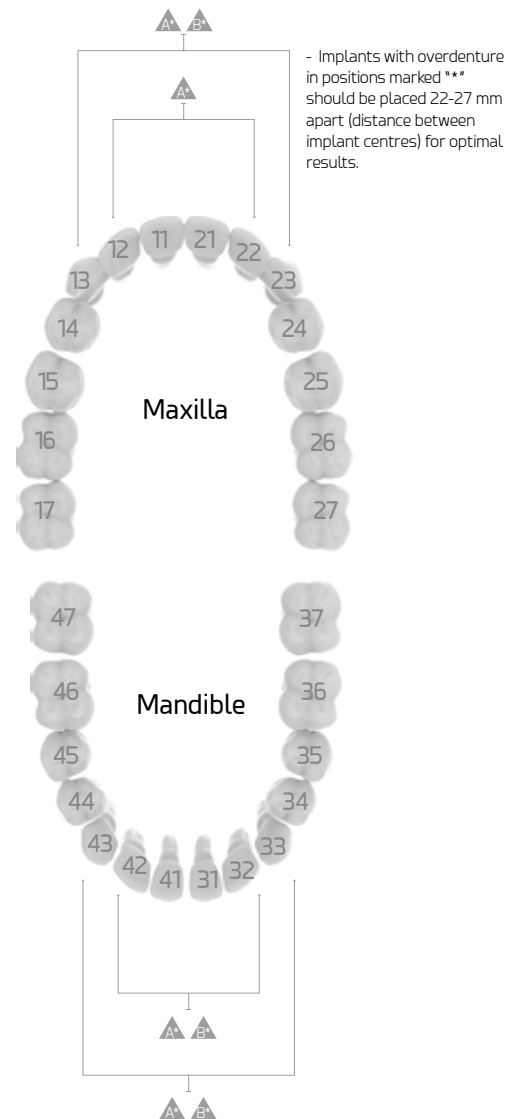

Recommendations for use

All implant planning must respect the natural biomechanical stability of the oral cavity and allow natural emergence of the dental crown through the soft tissue by means of an implant with a prosthetic platform that has a diameter that is proportionally smaller than the emergence diameter of the tooth to be restored. The implantologist must assess the quantity and quality of bone currently in the implant area and consider the need for prior or simultaneous bone regeneration, as appropriate.

Ziacom® has a wide range of implants available to cover every reconstruction possibility. The triangles identified with letters on the periodontal chart represent the implant diameters and platforms recommended for those tooth positions. These recommendations are valid for replacing teeth with single-unit restorations, bridges or partial or complete implant-retained, tissue-supported dentures.

Remember to maintain minimum distances between adjacent implants and between implants and teeth in order to preserve interdental papilla, bone vascularisation and natural emergence profiles.

Selection of the appropriate implant for each case is the sole responsibility of the implantologist. Ziacom Medical advises all clinicians to take into account the warnings based on scientific evidence which can be found in the product catalogues and our website.

■ CLARIFICATIONS ON DRILLING MEASUREMENTS AND TECHNIQUES

- **IMPLANT SIZE:** identifies the diameter and length of the implant.
- **IMPLANT BODY:** diameter of the implant core.
- **DRILL SIZE:** diameter of the drill.
- **DRILLING TECHNIQUE:** we have developed various drilling protocols to enable you to deal with different situations that arise in a schematic way when performing implant surgery.

Periodontal chart

ZMR · ZMRs

Implant diameter⁽¹⁾

▲ RP ▲ RP
Ø2.50 mm Ø2.80 mm

(1) Diameters available for analogue platforms

Implant crown diameter

▲ RP ▲ RP
Ø2.50 mm Ø2.80 mm

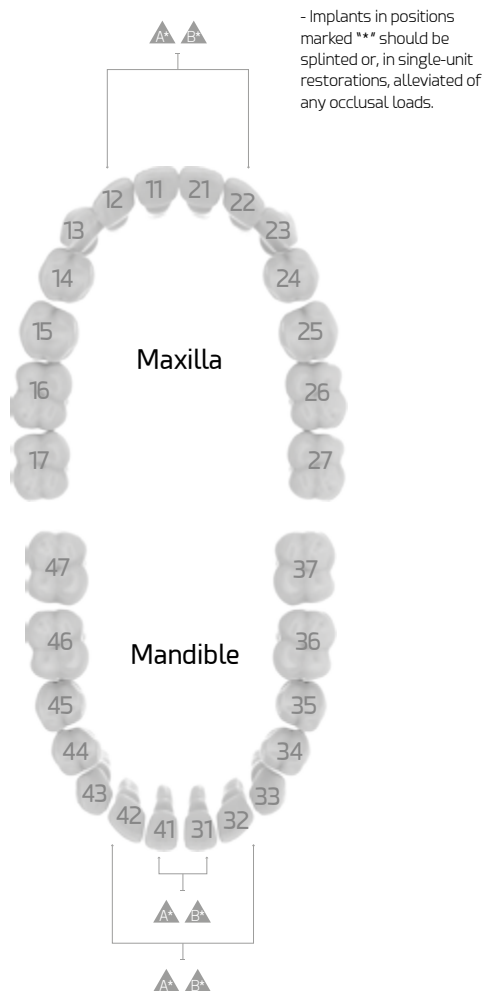

For more information on implant size selection see the literature available at www.ziacom.com/biblioteca



Product sheet

Title, section and paragraph

Abutments
Direct-to-implant restorations

Product name

Product image

Product table:
- Platform
- System
- Height (H)
- Diameter (Ø)
- Prod. reference

OVERDENTURE

ZMK

Related abutments

Kirator transfer abutment cap

Plat.	Height (H)	Reference
Kirator	6,50	TKPK3400

Pack of 4 units. **DO NOT** sterilise in the autoclave. **Scriptable**

Kirator analogue

Plat.	Length (L)	Reference
Kirator	13,00	ANTORK01

Pack of 4 units. **DO NOT** sterilise in the autoclave. **Scriptable**

Kirator processing pack



System: Kirator processing pack Reference: TPFS200

Kirator processing pack comprising: Titanium housing with black, white, clear and purple, transparent and pink plastic retainers.

Sterilise the metal housing in the autoclave. The plastic retainers and disc must be cold sterilised. See the Cleaning and Disinfection Instructions on the Ziacom® website.

System	Retention (kg)	Reference
Kirator	Light/2,00 kg	TPK300
	Standard/1,80 kg	TPK200
	Strong/2,70 kg	TPK300

Pack of 4 Kirator plastic retainers.

DO NOT sterilise in the autoclave, use cold sterilisation. Maximum divergence of 2° between implants.

Kirator divergent processing pack



System: Kirator divergent processing pack Reference: TPFS200

Kirator divergent processing pack comprising: Titanium housing with black, white, clear and purple, transparent and pink plastic retainers.

Sterilise the metal housing in the autoclave. The plastic retainers and disc must be cold sterilised. See the Cleaning and Disinfection Instructions on the Ziacom® website.

System	Retention (kg)	Reference
Kirator	Light/2,00 kg	TPK100
	Standard/1,80 kg	TPK220
	Strong/2,70 kg	TPK330

Pack of 4 Kirator plastic retainers - divergent.

DO NOT sterilise in the autoclave, use cold sterilisation. Maximum divergence of 4° between implants.

Example sequence



Kirator divergent processing pack reference: TPK100, TPK220, TPK330 are subject to availability.

www.ziacom.com

Product line diagram

All the dimensions given in this catalogue are expressed in millimeters (mm)

Product features

Additional information

Symbology

Symbol	Meaning	Symbol	Meaning	Symbol	Meaning
	Rotatory element		Tx30 connection		Made from cobalt chromium + castable plastic
	Non-rotatory element		Size in millimeters		Made from cobalt chromium
	Use with manual torque		45° screw support		Made from PEEK
	Maximum operating torque		90° screw support		Made from castable plastic
	Ratchet torque range		Use in rotation with a CA		Made from plastic
	Galaxy connection		Maximum rotation speed		Recommended sterilisation temperature
	Screw connection		Maximum number of uses		Unsterilised product
	Kirator connection		Single-use product		Use with abundant irrigation
	Basic connection		Made from grade 5 ELI (extra-low interstitial) titanium		Maximum angle
	XDrive connection		Made from stainless steel		

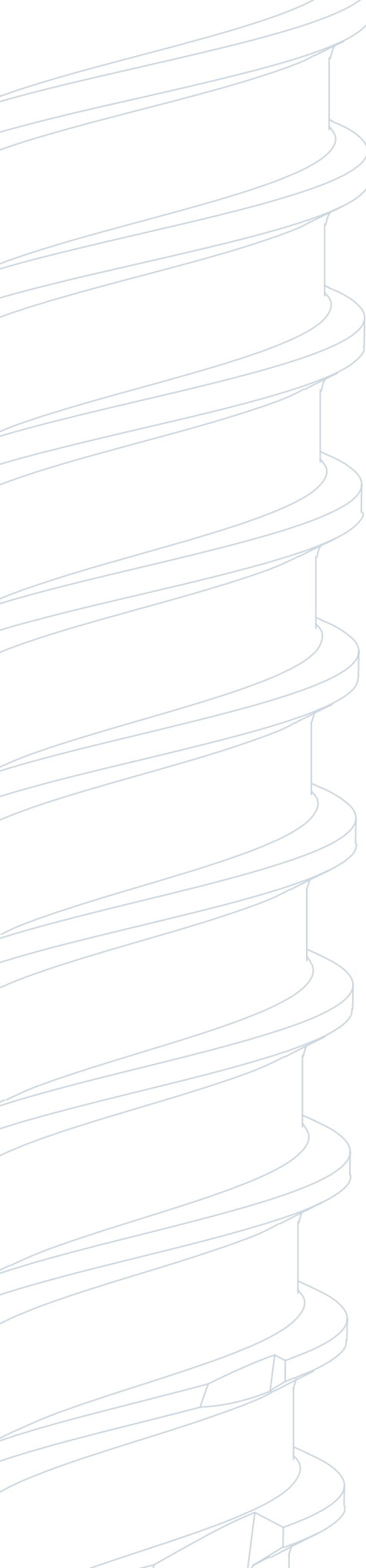

ZMK · ZMR

Abutments

Direct-to-implant
restorations



Abutments

Direct-to-implant restorations

OVERDENTURE

ZMK



Related abutments

Kirator transfer abutment cap

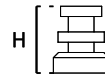

Platf.	Height (H)	Reference
Kirator	6.50	TCRK3400



Pack of 4 units. DO NOT sterilise in an autoclave. Sculptable.

Kirator analogue

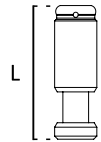

Platf.	Length (L)	Reference
Kirator	13.00	IATORK01



Kirator processing pack

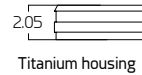

System	Reference
Kirator processing pack	TP8520

Kirator processing pack comprising: Titanium housing with black reliner, spacer and purple, transparent and pink plastic retainers.

Sterilise the metal housing in the autoclave. The plastic retainers and disc must be cold sterilised. See the Cleaning and Disinfection Instructions on the Ziacom® website.

System	Retention (kg)	Reference
Kirator	Light/1.20 kg	TPK100
	Standard/1.80 kg	TPK200
	Strong/2.70 kg	TPK300

Pack of 4 Kirator plastic retainers.



DO NOT sterilise in the autoclave; use cold sterilisation. Maximum divergence of 22° between implants.

Kirator divergent processing pack

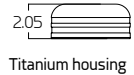

System	Reference
Kirator processing pack	TP8520D

Kirator divergent processing pack comprising: Titanium housing with black reliner, spacer and purple, transparent and pink plastic retainers.

Sterilise the metal housing in the autoclave. The plastic retainers and disc must be cold sterilised. See the Cleaning and Disinfection Instructions on the Ziacom® website.

System	Retention (kg)	Reference
Kirator	Light/1.20 kg	TPK110
	Standard/1.80 kg	TPK220
	Strong/2.70 kg	TPK330

Pack of 4 Kirator plastic retainers - divergent.



DO NOT sterilise in the autoclave; use cold sterilisation. Maximum divergence of 44° between implants.

Example sequence



Kirator divergent processing pack references TPK110/TPK220/TPK330 are subject to availability.

CEMENTED

ZMR · ZMRs



Related abutments

Healing abutment

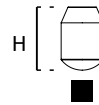

Platf.	Height (H)	Reference
▲	6.00	HABA05



UCLA

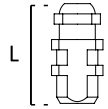

Platf.	Length (L)	Reference
▲	9.70	NUXP01



Pack of 4 units. Make sure the UCLA abutment is properly engaged on the abutment before waxing. DO NOT sterilise in an autoclave. Sculptable.

Also acts as a Snap-On transfer abutment cap.

Snap-On transfer abutment cap

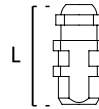

Platf.	Length (L)	Reference
▲	9.70	NUXP01



Pack of 4 units. Make sure the plastic transfer abutment cap is seated properly on the abutment before taking the impression. DO NOT sterilise in an autoclave. Sculptable. Also acts as an UCLA abutment

Implant analogue

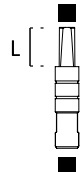

Platf.	Length (L)	Reference
▲	5.00	IAXP02



3D implant analogue

Platf.	Length (L)	Reference
▲	5.00	IAXP02D



ZIACOR® CAD-CAM

ZiaCam® to implant scanbody

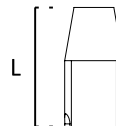

Platf.	Length (L)	Reference
▲	9.00	FNSY2341



Example sequence



Prosthetic modelling

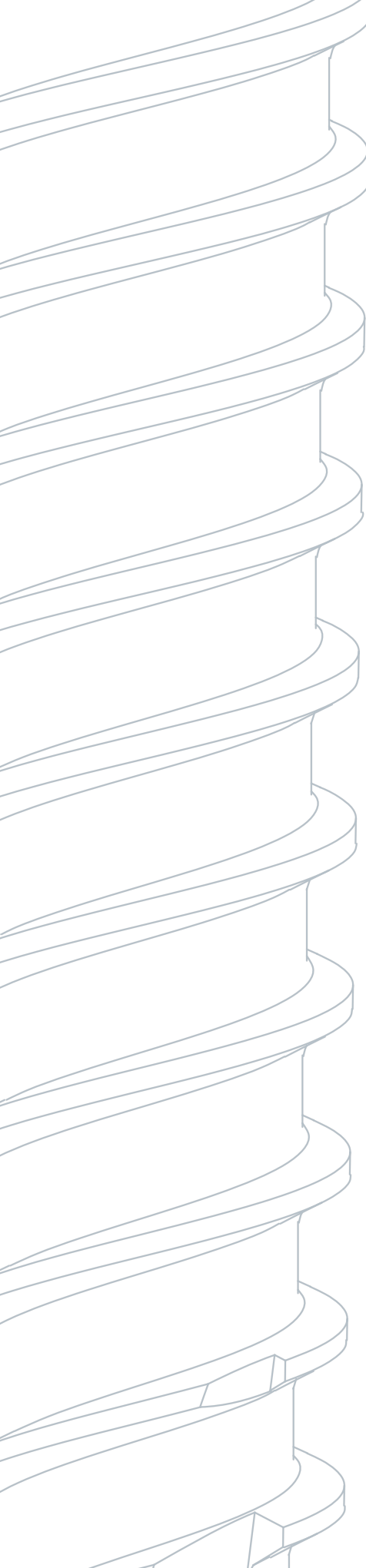

ZMK · ZMR

Surgical
instruments



Surgical instruments

Surgical boxes



Available ZMK boxes

Platf.	Contents	Reference
▲	Empty	BOX600X
	Basic, manual. Surgical ratchet	BOX600KXS
	Basic, manual. Torque wrench	BOX600KXSK
	Basic, CA. Surgical ratchet	BOX600KMXS
	Basic, CA. Torque wrench	BOX600KMXSK
	Complete. Surgical ratchet	BOX600KXC
	Complete. Torque wrench	BOX600KXCK

Available ZMR boxes

Platf.	Contents	Reference
▲	Empty	BOX600X
	Basic, manual. Surgical ratchet	BOX601XS
	Basic, manual. Torque wrench	BOX601XSK
	Basic, CA. Surgical ratchet	BOX600MXS
	Basic, CA. Torque wrench	BOX600MXSK
	Complete. Surgical ratchet	BOX601XC
	Complete. Torque wrench	BOX601XCK

Available ZMRS boxes

Platf.	Contents	Reference
▲	Empty	BOX600
	Basic, manual. Surgical ratchet	BOX600RXS
	Basic, manual. Torque wrench	BOX600RXSK
	Basic, CA. Surgical ratchet	BOX600RMXS
	Basic, CA. Torque wrench	BOX600RMXSK
	Complete. Surgical ratchet	BOX600RXC
	Complete. Torque wrench	BOX600RXCK



Material: Radel

Ensure boxes do not touch the walls of the autoclave to avoid damage.

■ Contents of surgical boxes

REF	Description
MSID02	Lance drill. ZMK/ZMR. Ø2.00mm. Millimeter. Stainless steel
OTD18ZM	Stepped surgical drill. ZMK/ZMR. Ø1.80mm. Millimeter. Stainless steel
OTD20ZM	Stepped surgical drill. ZMK/ZMR. Ø2.00mm. Millimeter. Stainless steel
DEXT10	Drill extender. Stainless steel
PARA70	Double paralleling pin. ZMK/ZMR. Ø1.80/2.15mm. Grade 5 ELI titanium
LAXP	Implant adaptor. Ratchet/Manual. Stainless steel
MAXP	Implant adaptor. CA. Stainless steel
LOSD02	Kirator/ZMK adaptor. CA. Stainless steel
LOSD01	Kirator/ZMK adaptor. Ratchet/Manual. Stainless steel
RATC50	Implant ratchet. Stainless steel
MPU10	Tissue punch. RP. CA. Stainless steel
TORK50	Adjustable torque wrench. 10/20/30/40/50/60/70 Ncm. Stainless steel

ZMK



Surgical instruments

SURGICAL DRILLS

Lance drill



Platf.	Diameter (Ø)	Length (L)	Reference
▲	2.00	19.70	MSID02

Millimeter: 10/115/13



Stepped surgical drill

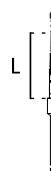

Platf.	Diameter (Ø)	Length (L)	Reference
▲	1.40/2.25	17.00	OTD18ZM
▲	1.70/2.55	17.00	OTD20ZM

Millimeter: 10/115/13



Drill extender



Platf.	Length (L)	Reference
Universal	13.50	DEXT10



PROBES

Double paralleling pin

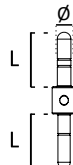

Platf.	Length (L)	Diameter (Ø)	Reference
▲	8.00	1.85/2.15	PARA70



KEYS

ZMR insertion key. Ratchet/Manual

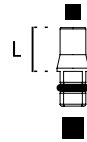

Platf.	Length (L)	Reference
Universal	6.80	LAXP

- Square - 2x2 mm
- Square - 4x4 mm



ZMR insertion key. CA



Platf.	Length (L)	Reference
Universal	6.30	MAXP

- Square 2x2 mm



Kirator insertion key

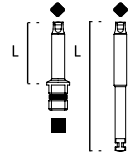

Platf.	Length (L)	Reference
Kirator	13.60/Manual 20.00/CA	LOSD01 LOSD02

- ◆ Square 2.11 mm / ■ Square 4x4 mm



ADAPTERS

Universal adapter. Ratchet/Manual

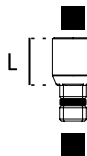

Platf.	Length (L)	Reference
Universal	7.20	LAEX

- Square 4x4 mm



Universal adapter, CA

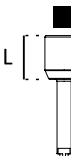

Platf.	Length (L)	Reference
Universal	7.20	MAEX

- Square 4x4 mm



Tissue punch

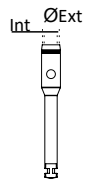

Platf.	Diameter (∅)	Reference
▲	2.80/3.30	MPU10

DLC surface treatment



RADIOGRAPHIC TEMPLATE

ZMK and ZMR/ZMRS radiographic templates

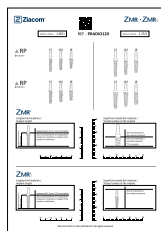
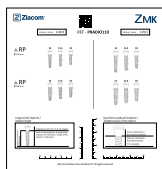

Platf.	Model	Reference
▲	ZMK	PRADIO110
▲	ZMR - ZMRS	PRADIO120

Scales 1:1 and 1:1.25

Material: transparent acetate. Non-sterilisable material

See the literature available at www.ziacom.com/biblioteca

RATCHETS

Implant ratchet



Platf.	Length (L)	Reference
Universal	69.80	RATC50

- Square 4x4 mm



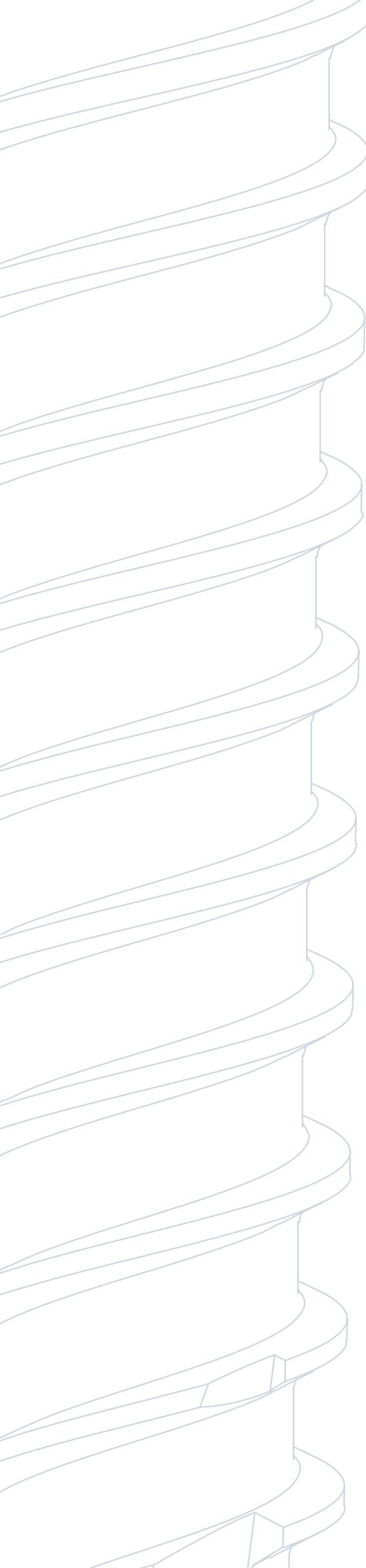

ZMK · ZMR

Prosthetic
instruments



Prosthetic instruments

Prosthetic box

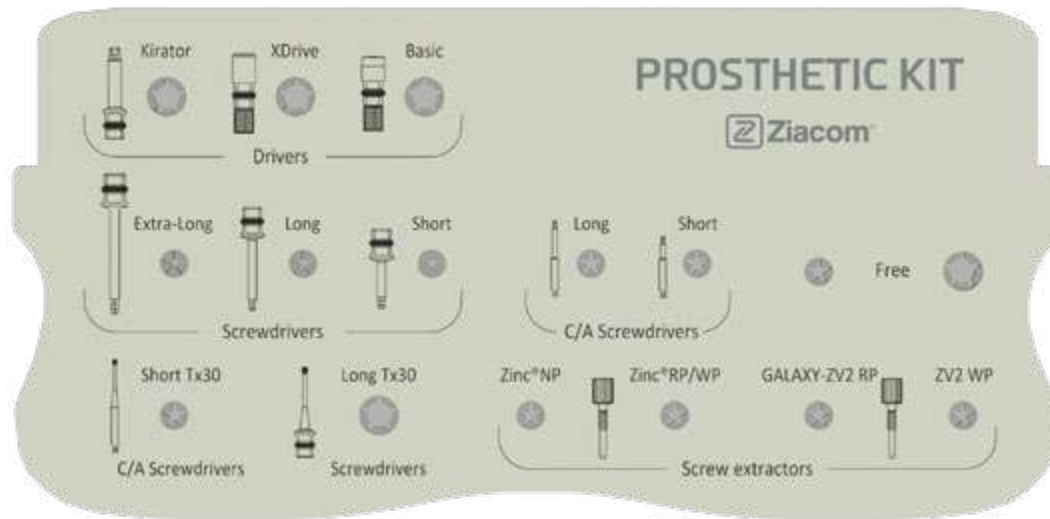

■ Contents of prosthetic boxes available

Contents	Reference
Empty	BOXPN
Basic	BOXPSN
Complete	BOXPCN



Material: Radel.

Ensure boxes do not touch the walls of the autoclave to avoid damage.



■ Contents of prosthetic boxes

REF	Description	BOXPSN	BOXPCN
LOSD01	Kirator insert key. Ratchet	●	●
MABA100	Basic insert key. Short. Ratchet. Grade 5 ELI titanium	●	●
MABA200	XDrive insert key. Short. Ratchet. Grade 5 ELI titanium	●	●
MADW10	Screwdriver adapter handle. 4x4. Manual	●	●
SMSD1	Screwdriver tip. Ø125 mm. Short. Ratchet	●	●
LMSD1	Screwdriver tip. Ø125 mm. Long. Ratchet	●	●
XLMSD1	Screwdriver tip. Ø125 mm. Extralong. Ratchet		●
MESD	Screwdriver tip. Ø125 mm. Long. CA.	●	●
MESD01	Screwdriver tip. Ø125 mm. Short. CA.	●	●
MESD1TX	Tx30 screwdriver tip. Long. CA.	●	●
LMSD1TX	Tx30 screwdriver tip. Long. Ratchet	●	●
EDSZ20 *	ZPlus extractor screw. Zinic®. NP. Grade 5 ELI titanium		●
EDSZ34 *	ZPlus extractor screw. Zinic®. RP/WP. Grade 5 ELI titanium		●
EDSG34 *	Abutment extractor screw. Galaxy/ZV2. RP. Grade 5 ELI titanium		●
EDSG50 *	Abutment extractor screw. ZV2. WP. Grade 5 ELI titanium		●
TORK50	Regulable torque wrench. 10/20/30/40/50/60/70 Ncm	●	●

* Product not included in the ZMK · ZMR system.

KEYS

Kirator insertion key

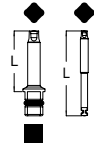

System	Length (L)	Reference
Kirator	13.60/Ratchet/Manual 20.00/CA	LOSD01 LOSD02 *

◆ Square 2.11 mm / ■ Square 4x4 mm



* Ref. LOSD02 is NOT included in the prosthetic box.

Basic insertion key. Ratchet

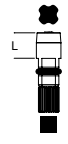

System	Length (L)	Reference
Basic	5.00/Short	MABA100
	13.00/Long	MABA110 *

◆ Basic / ■ Square 4x4 mm



* Ref. MABA110. is NOT included in the prosthetic box.

XDrive insertion key. Ratchet

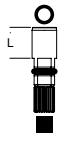

System	Length (L)	Reference
XDrive	6.00/Short	MABA200
	13.00/Long	MABA210 *

○ XDrive / ■ Square 4x4 mm



* Ref. MABA210. is NOT included in the prosthetic box.

SCREWDRIVERS

Screwdriver adapter handle

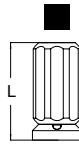

Platf.	Length (L)	Reference
Universal	15.50	MADW10

■ Square 4x4 mm



Screwdriver tip. Ratchet

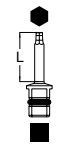

Platf.	Length (L)	Reference
Universal	9.50/Short	SMSD1
	14.50/Long	LMSD1
	27.00/Extralong	XLMSD1

■ Square 4x4 mm



Screwdriver tip. CA

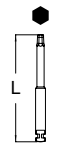

Platf.	Length (L)	Reference
Universal	20.00/Short	MESD01
	25.00/Long	MESD



Tx30 screwdriver tip. CA



System	Length (L)	Reference
Tx30	26.00/Short	MESD01TX *
	32.00/Long	MESDTX



Do not exceed 30 Ncm as it could cause severe damage to the screwdriver and screw.

* Ref. MESD01TX is NOT included in the prosthetic box.

Tx30 screwdriver tip. Ratchet

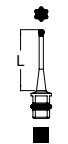

System	Length (L)	Reference
Tx30	12.00/Short	SMSD1TX *
	18.00/Long	LMSD1TX

■ Square 4x4 mm



Do not exceed 30 Ncm as it could cause severe damage to the screwdriver and screw.

* Ref. SMSD1TX is NOT included in the prosthetic box.

Tx30 prosthetic screwdriver. Manual

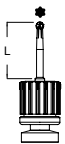

System	Length (L)	Reference
Tx30	12.00/Short	SMSD1TX *
	18.00/Long	LMSD1TX *



Do not exceed 30 Ncm as it could cause severe damage to the screwdriver and screw.

* Ref. SMSD1TX/LMSD1TX are NOT included in the prosthetic box.

Prosthetic instruments

EXTRACTOR SCREW

ZPlus extractor screw



Platf.	Length (L)	Reference
● Yellow	25.00	EDSZ20 *
● Blue ● Pink	23.70	EDSZ34 *

Anodised ■ NP ■ RP/WP



Galaxy/ZV2 abutment extractor screw



Platf.	Length (L)	Reference
■ Blue	25.00	EDSG34 *
■ Pink	26.80	EDSG50 *

Anodised ■ RP ■ WP



* Product not included in the ZMK · ZMR system.

RATCHETS

Regulable torque wrench



Platf.	Length (L)	Reference
Universal	86.80	TORK50

■ Square 4x4 mm



Complementary instruments

CA to ratchet adapter

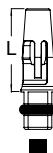

Platf.	Length (L)	Reference
Universal	12.00	MC10Z

■ Square 4x4 mm



NOT included in the prosthetic box.

Extractor + Retainer inserter handle

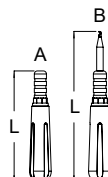

Platf.	A Length (L)	B Length (L)	Reference
Kirator	81.50	110.40	MBEI3610
ZM-Equator			



NOT included in the prosthetic box.

Retainer inserter

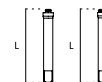

Platf.	Length (L)	Reference
Kirator	32.00	MBEI3602
ZM-Equator	32.00	MBEI3603



Kirator / ZM-Equator plastic coping insertion tool.
NOT included in the prosthetic box.

Retentive joints instruments



Platf.	Measure	Reference
Universal	2x1	RREI0030

Pack of 10 units.

Simplified
surgical
protocol

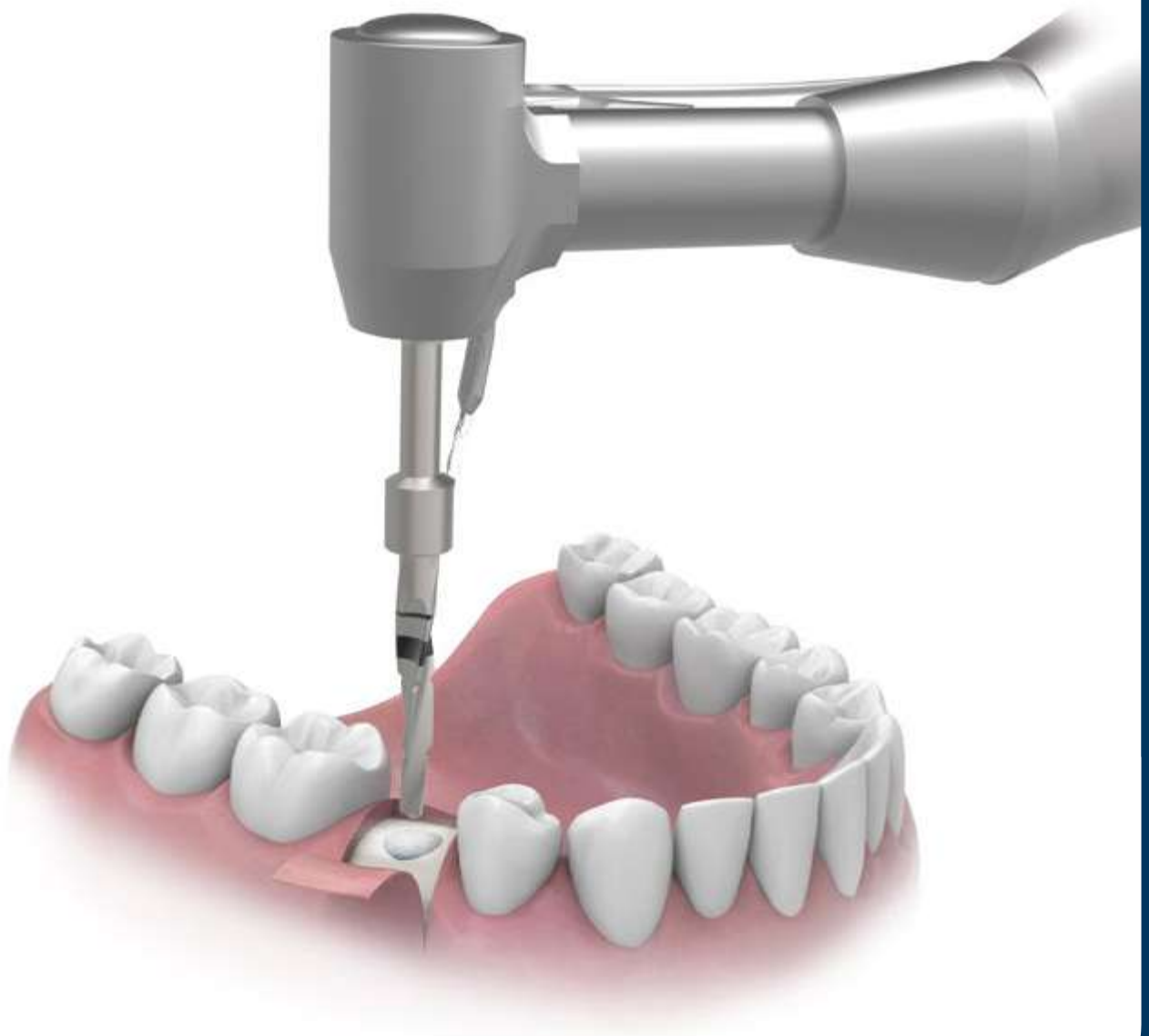

Simplified surgical protocol

Characteristics of the ZMK · ZMR · ZMRS drilling system

■ Ziacom® drill system

Ziacom® implant system drills are made from stainless steel. A laser marking on the bur's shank identifies its inner and outer diameters and its length, while the horizontal laser marked bands on the active section corresponds to the different lengths of the implants (drills graduated in mm). The bur tip is 0.5 mm long and is not included in the laser marked measurements.

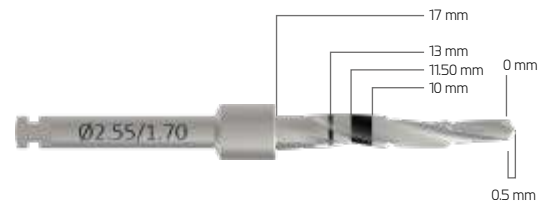

■ Probes

Check the depth of the surgical site, especially when not using drill stops. To check the surgical bed axis, the paralleling pins are available in different diameters according to the drilling sequence.

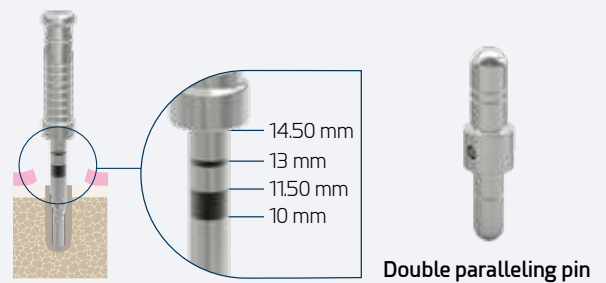

■ Short and long insertion tools for ratchets and contra-angle handpieces

The insertion tool for contra-angle handpieces or ratchets has been designed for transporting implants from their No Mount vial to the surgical site ready for insertion.



ZMK

ZMR · ZMRS

ZMK drilling protocol

Rotation
 Irrigation required
 Drill diameter
 See instructions
 Torque

The specified speeds are recommended

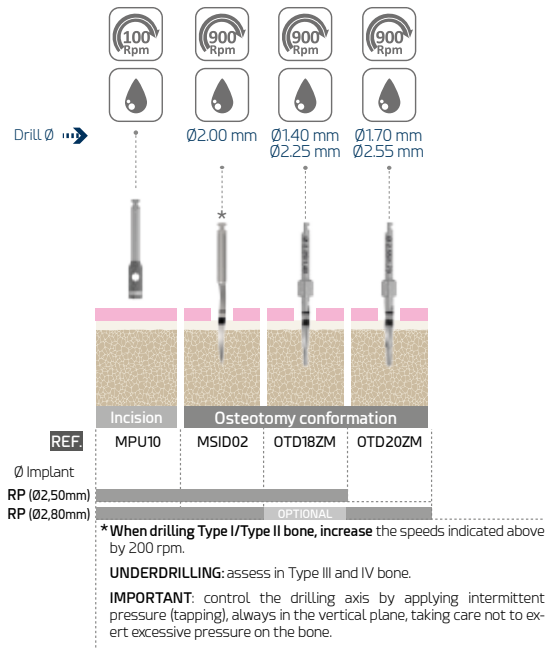

ZMK implant insertion

■ Insertion



■ Removing the ZMK plastic mount

Point of insertion at which to remove the mount according to bone type

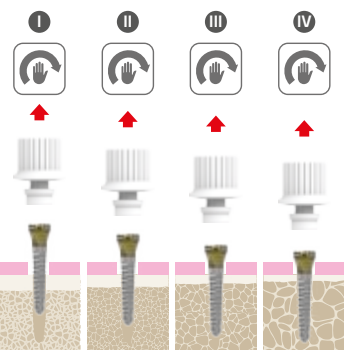

Remove the ZMK implants from the vial in the blister pack and insert them into the surgical site by hand using the plastic mount until sufficient mechanical anchorage is achieved for its removal. Disengage the mount while turning it to insert it.

Do not fully insert the implant with the plastic mount.

After removing the mount, use the ratchet or contra-angle insertion keys to insert the implant platform to the position indicated in the protocol.

■ Direct insertion



Simplified surgical protocol

ZMR · ZMR S drilling protocol

Rotation Irrigation required Drill diameter See instructions Torque

The specified speeds are recommended

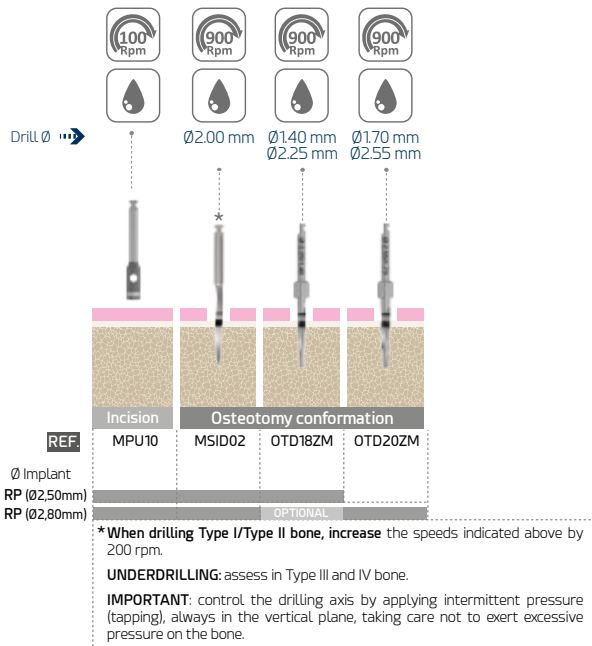

ZMR · ZMR S implant insertion

■ Insertion



■ Removing the ZMR · ZMR S plastic mount *

Point of insertion at which to remove the mount according to bone type

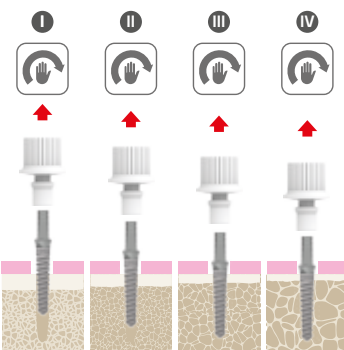

Remove the ZMR · ZMR S implants from the vial in the blister pack and insert them into the surgical site by hand using the plastic mount until sufficient mechanical anchorage is achieved for its removal. Disengage the mount while turning it to insert it.

Do not fully insert the implant with the plastic mount.

After removing the mount, use the ratchet or contra-angle insertion keys to insert the implant platform to the position indicated in the protocol.

■ Direct insertion



Implants insertion ZMK · ZMR · ZMRS

■ Crestal placement of implants

The Ziacom® implants platform must be placed in a supracrestal position.

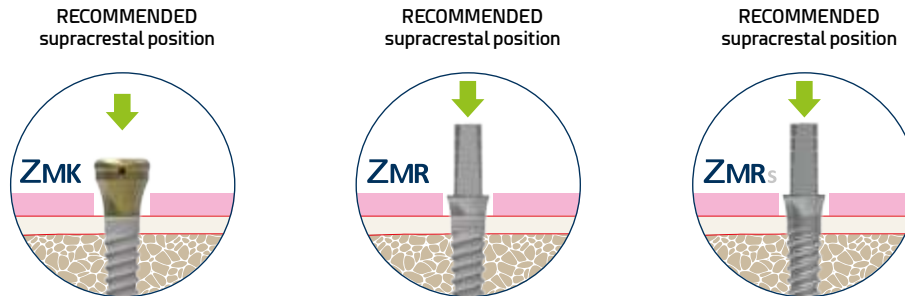

■ Bone types

Lekholm and Zarb classification (1985)



TYPE IV BONE - SOFT BONE

- Thin cortical layer surrounding a low-density trabecular bone.



TYPE II & III BONE - MEDIUM BONE

- Type II: thick layer of compact bone surrounding a dense trabecular bone.
- Type III: thin cortical layer surrounding a dense trabecular bone.



TYPE I BONE - HARD BONE

- Composed almost entirely of homogeneous compact bone.

Simplified surgical protocol

General recommendations

Consider during intervention



Surgical drills must be inserted into the contra-angle handpiece with the motor stopped, ensuring that they are seated and rotate properly before starting drilling. Treat drills with the utmost care; the slightest damage to the tips could compromise their effective operation.



Each instrument should only be used for the specific use recommended by the manufacturer.



Damaged instruments must be disposed of according to local regulations.



Implantologists should keep one of the identification labels supplied with the product in the patient's file so that it may be traced correctly.

IMPORTANT WARNINGS

About implant insertion

Respect the recommended maximum rpm. screwdrivers and insertion keys for contra-angle: maximum **25 rpm**.



Maximum insertion torque:

The implant should be inserted with controlled torque according to the density and quality of the bone at the implant site.

The recommended insertion torque based on scientific evidence ranges from **35 to 50 Ncm** according to each case and is not limited to a single torque.



Avoid cortical stress and deformation of the instrument and implant connection:

The Ziacom® surgical protocol establishes crestal positioning of the implant platform.

To avoid cortical stress and deformation of the insertion key and/or implant connection, and also to avoid galling between the implant and the mount, the recommended maximum speed (**25 rpm**) and maximum torque (**50 Ncm**) must be respected when inserting with a contra-angle (CA) handpiece.



When using a ratchet, it is necessary to monitor resistance during insertion. If there is any resistance, the implant should be removed by turning it twice (to release the bone from the tension created and free the thread) and then, after a few seconds, the implant should be inserted again, repeating this process as many times as is necessary.

Ignoring these important warnings could cause:

- Irreversible deformation of the mount.
- Difficulty removing the mount.
- Irreversible deformation of the implant's internal/external connection.
- Difficulty disassembling the instrument/implant assembly.
- Difficulties during implant insertion.
- Lack of primary stability due to loss of supporting bone.
- No osseointegration due to bone necrosis as a result of excessive compaction of the bone.

Always consult the surgical and prosthetic protocols published in this catalogue, as well as the other documents available in the "Reference literature" section of our website www.ziacom.com/biblioteca which explained the procedures, protocols and instructions for use before using the ZMK·ZMR·ZMR S system by Ziacom®.



Cleaning, disinfection and sterilisation



Cleaning, disinfection and sterilisation

The protocols described in this section must only be carried out by personnel qualified to clean, disinfect and sterilise the dental materials specified here in.

Cleaning and disinfection instructions

Applicable for instruments, surgical and prosthetic boxes and plastic retainer caps.

■ Disassembly

1. Dismount* the appropriate instruments, for example manual ratchets, drills or drill stops.
2. Remove the various components from the surgical or prosthetic box for correct cleaning.

■ Cleaning and disinfection

For disinfecting instruments and surgical boxes:

1. Submerge the instruments in a detergent/disinfectant solution** suitable for dental instruments to help eliminate any adhered biological residues. If an ultrasound bath is available***, confirm that the detergent/disinfectant solution is indicated for use with this type of equipment.
2. Manually remove any biological residues with a non-metallic brush and pH-neutral detergent.
3. Rinse with copious water.
4. When cleaning the surgical and prosthetic boxes, always use a pH-neutral detergent and non-abrasive utensils to avoid damaging the surface of the boxes.
5. Dry the materials with disposable cellulose, lint-free clothes or compressed air.

For disinfecting plastic caps and spacers:

1. Submerge in a neat benzalkonium chloride solution for 10 minutes.
2. Rinse with distilled water.
3. Dry the caps and spacer before use.

■ Inspection

1. Check that the instruments are perfectly clean; if not, repeat the cleaning and disinfection steps.
2. Discard any instruments with imperfections and replace them before the next procedure.
3. Check that the instruments and the surgical and prosthetic boxes are perfectly dry before reassembling the parts and proceeding to their sterilisation.

* See the assembly disassembly manuals at www.ziacom.com/biblioteca

** Follow the instructions from the disinfectant's manufacturer to determine the correct concentrations and times.

*** Follow the instructions from the ultrasound bath's manufacturer to determine the correct temperature, concentration and times.

Sterilisation instructions for steam autoclave

Applicable to orthodontic implants, abutments, and surgical and prosthetic instruments and boxes.

1. Introduce each material separately in individual sterilisation bags, then seal the bags. For joint sterilisation, place the instruments in their surgical box, introduce the box into a sterilisation bag and seal the bag.
2. Place the bags to be sterilised in the autoclave.
3. Sterilise in a steam autoclave at 134°C/273°F (max. 137°C/276°F) for 4 min (minimum) and at 2 atm. Torque wrenches must be sterilised in 3 vacuum cycles at 132°C/270°F for a minimum of 1.5 minutes and vacuum-dried for a minimum of 20 minutes.

For the United States only: The validated and recommended sterilisation cycle for the US must be performed in a steam autoclave at 132°C/270°F for at least 15 min and with the drying time of at least 15 - 30 min.

IMPORTANT

Make sure the drying stage is allowed to run to completion, otherwise the products may be damp.

Check the sterilisation equipment if the materials or sterilisation bags are damp at the end of the sterilisation cycle.

Perform the necessary maintenance actions on the autoclave according to the established periodicity and following the manufacturer's instructions.



Storage of Ziacom® products

- Store the products in their original packaging and in a clean, dry location until they are used.
- After sterilisation, keep the products in the sealed sterilisation bags and in a clean, dry location.
- Never exceed the use by date indicated by the manufacturer of the sterilisation bags.
- Always follow the indications of the manufacturer of the sterilisation bags.

General recommendations

- Never use damaged or dirty material; never reuse single-use products. The user is responsible for following the instructions described in this document correctly.
- The attention to piercing or sharp elements. Gloves should be worn when cleaning the materials to avoid accidents during handling.
- Follow the safety instructions indicated by the manufacturer of the disinfectant agent.
- The product's sterility cannot be guaranteed if the sterilisation bag is open, damaged or damp.
- Respect all stages of the sterilisation process. If the materials or sterilisation bags contain traces of water or moisture, check the autoclave and repeat the sterilisation.
- Orthodontic abutments and implants are supplied UNSTERILISED and must always be sterilised before use.
- Instruments and surgical and prosthetic boxes are supplied UNSTERILISED and must always be sterilised before use and cleaned and disinfected after use.
- The sterilisation, cleaning and disinfection processes gradually deteriorate the instruments. Inspect the instruments thoroughly to detect any signs of deterioration.
- Avoid contact between products made from different materials (steel, titanium, etc.) during the cleaning, disinfection and sterilisation processes.
- Ziacom Medical SL recommends these instructions are implemented for the correct maintenance and safety of their products; accordingly, the company refuses any liability for any damage to the products that could arise if the user applies alternative cleaning, disinfection and sterilisation procedures.

See www.ziacom.com/biblioteca for the latest version of the cleaning, disinfection and sterilisation instructions.





See the latest version of the general conditions of sale on our website www.ziacom.com.

Check the availability of each product in your country.

All rights reserved. No part of this document may be reproduced or stored in any medium or reproduction system, nor transmitted in any way or under any concept, electronically, mechanically, in photocopies, recording or any other mean not considered here without the permission of holder of the copyright, editing and printing. Ziacom® is a registered trademark of Ziacom Medical SL.

See the latest version of the catalogues available at www.ziacom.com.

EN | ENGLISH



www.ziacom.com

Ziacom Medical SL

Calle Búhos, 2
28320 Pinto - Madrid - ESPAÑA
Tfno.: +34 91 723 33 06
info@ziacom.com

Ziacom Medical Portugal Lda

Av. Miguel Bombarda, 36 - 5° B
1050 -165 - Lisboa - PORTUGAL
Tel: +351 215 850 209
info.pt@ziacom.com

Ziacom Medical USA LLC

333 S.E 2nd Avenue, Suite 2000
Miami, FL 33131 - USA
Phone: +1 (786) 224 - 0089
info.usa@ziacom.com