

ZM4

External hex connection implants

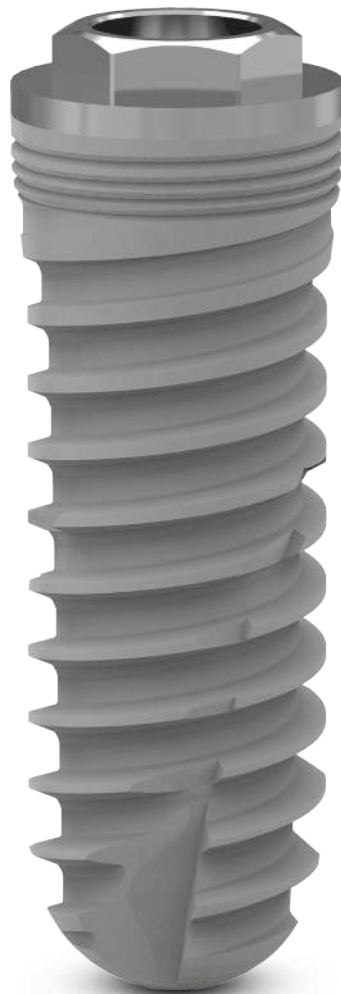

ZM4

Surgical procedure manual



Important information

Please read carefully before using Ziacom® products

General information

This document contains basic information on the use of original Ziacom® dental implant systems, hereafter referred to as Ziacom® dental implants or simply Ziacom® products. This document has been created as quick guide for clinicians responsible for treatment, hereafter the "user", and, therefore, is neither an alternative nor a substitute for specialized training or professional clinical experience.

Ziacom® products must be used according to a suitable treatment plan and adhering strictly to the surgical and prosthetic protocols established by the manufacturer. Read the product-specific surgical and prosthetic protocols as well as the instructions for use and maintenance before using each Ziacom® product. You can find this information on our website, www.ziacom.com, or request it from your nearest authorised Ziacom® distributor.

Liability, safety and guarantee.

The instructions for the use and handling of Ziacom® products are based on internationally published literature, current clinical standards and our clinical experience, so they should be understood as general guiding information. The handling and use of Ziacom® products is the sole responsibility of the user as it is outside the control of Ziacom Medical SL. Ziacom Medical SL, their affiliates and/or their authorised distributors disclaim all responsibility, whether explicit or implicit, total or partial, for possible damage or injury caused by poor handling of the product or any other situation not considered in their protocols and manuals for the correct use of their products.

The user must ensure that the Ziacom® product is appropriate for the intended procedure and end purpose. Neither these instructions for use nor the work or handling protocols for the products release the user from this obligation. Ziacom® products must be used, handled and applied by professionals with the appropriate training and qualifications required according to current legislation in each country.

The total or partial use, handling and/or application of Ziacom® products at any stage of their implementation by personnel who are unqualified or lack the necessary training will automatically void any type of warranty and may cause severe damage to the patient's health.

Ziacom® products are part of their own system, with their own design characteristics and work protocols, including dental implants, abutments or prosthetic components and surgical or prosthetic instruments. The use of Ziacom® products in combination with elements or components from other manufacturers could result in treatment failure, damage to tissues or bone structures, inadequate aesthetic outcomes and severe damage to the patient's health. Therefore, only original Ziacom® products should be used.

The clinician in charge of the treatment is solely responsible for ensuring the use of original Ziacom® products and that they are used according to the corresponding instructions for use and handling protocols throughout the implant procedure. The use of any other non-original Ziacom® components, instruments or products, whether alone or in combination with any original Ziacom® products, will immediately void the warranty of the original Ziacom® products.

See the Ziacom Medical SL Warranty Programme (available on the website or by contacting Ziacom Medical SL, their affiliates or authorised distributors).

Warning. Not all Ziacom® products are available in all countries. Check availability in your country.

The Ziacom® brand and the names of other products and services, including their logos, that are mentioned in this document or on the website www.ziacom.com, are registered trademarks of Ziacom Medical S.L.

Ziacom Medical S.L. reserves the right to modify, change, remove or update any of the products, prices or technical specifications referenced on this website or in any of its documents without prior notification. All rights reserved. The reproduction of this document, whole or in part and in any medium or format, without the corresponding written authorisation from Ziacom Medical SL is prohibited.



Together for health

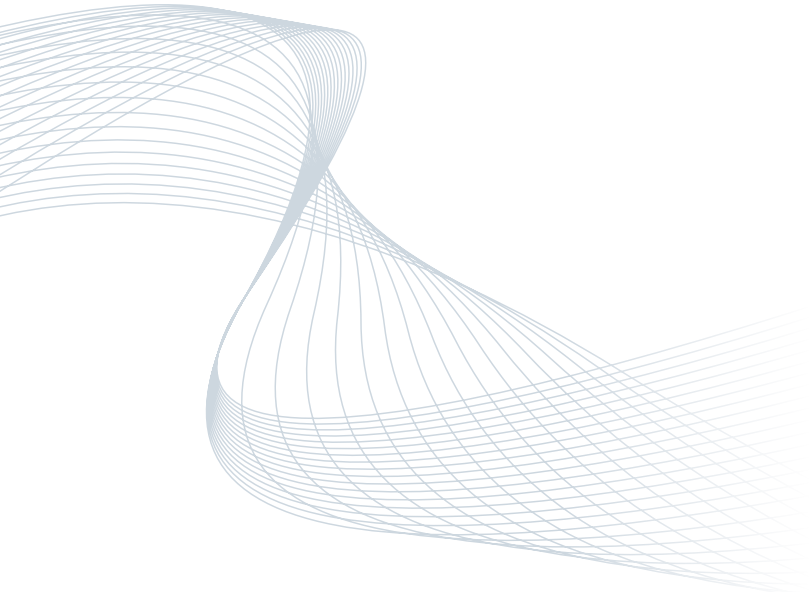

Index

ZM4 | External hex connection implants

Characteristics	06
Diameters and lengths	07
Surface treatments	08
- Titansure surface treatment	08
Product presentation	10
ZM4 references	11
Recommendations for use	12

ZM4 surgical protocol

General considerations	14
Steps of drilling protocol	16
Implant insertion using Mount ZPlus Titansure	18
Simplified surgical protocol	20
Cleaning, disinfection and sterilisation	24

Characteristics

CONNECTION

- External hex connection
- Screw channel with upper guide: facilitates screw insertion

NECK/COLLAR

- 0.4 mm machined ring: allows the prosthetic gap to be raised with respect to the bone crest in average/thick biotypes; avoids exposing the treated surface of irregular crests
- Microthread design: preserves marginal bone
- Microthread extension: improves load distribution
- Macrodesign: optimal cortical compression

BODY



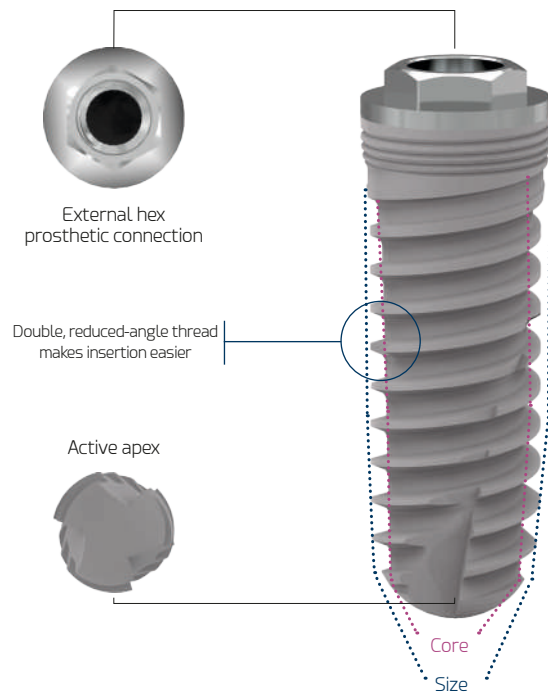



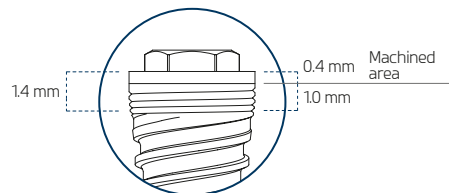

























- Reduced-angle active threads: improve stability during insertion and increase BIC (bone-to-implant contact)
- Double threaded: quick insertion and shorter surgical time
- Self-tapping active apex: facilitates insertion with underdrilling
- Transverse apical windows: collect remnants of bone during insertion
- Optimised morphology: high primary stability
- Atraumatic apex: no damage to anatomical structures



Dimensions of the implant's neck/collar



Diameters and lengths

Ø DIAMETER	Ø PLATFORM	LENGHT (L)				
		8,5	10	11,5	13	14,5
 NP 3,30	3,30					
 RP 3,70	4,10					
 RP 4,00						
 RP 4,30						
 WP 4,60	5,00					
 WP 5,00						

Dimensions in mm.

ZM4 implants

Surface treatments

■ Titansure surface

Implants inserted following surface treatment are known to benefit from improved osseointegration by increasing the bone-to-implant contact area. This is partly due to the implant's chemical composition and topographical characteristics.

With our **Titansure** surface treatment, at Ziacom Medical we have obtained a contaminant-free surface topography and optimal average macro- and microporosity values, which are key specifications for achieving prompt and proper osseointegration and, in turn, extremely reliable and predictable implants.

■ TITANSURE SURFACE ANALYSIS

Titansure is an SLA surface treatment created through a subtraction process involving sandblasting with white aluminium oxide and double acid etching with hydrofluoric acid and a sulphuric/phosphoric acid mix.

Surface morphology analysis

With the aid of a scanning electron microscope (FEI TENEO, Thermo Fisher Scientific Inc., Waltham, MA, USA), we can see the rough, porous surface creating numerous cavities with thin, sharp edges.

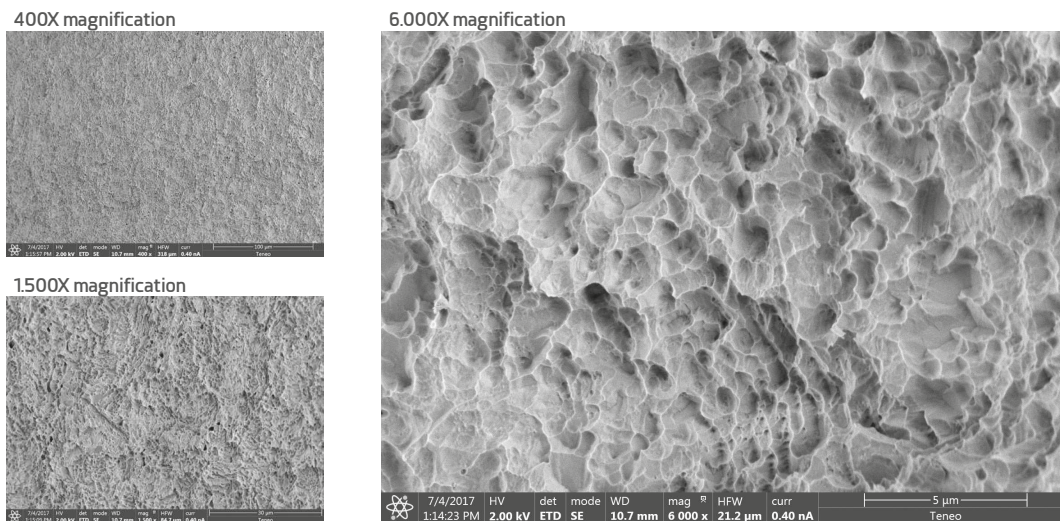

Surface elemental analysis

We used an energy-dispersive X-ray spectrometer (Octane Super, Edax-Ametek, Mahwah, NJ, USA) to analyse the chemical composition at the surface.

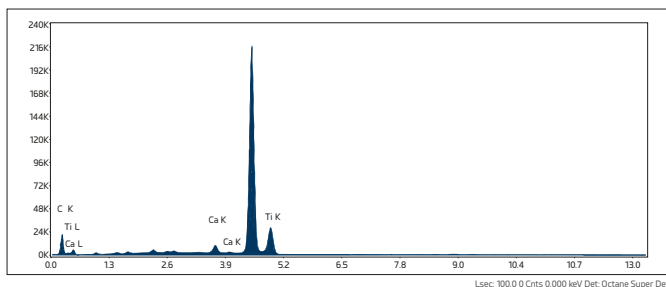

Compositional analysis of implant surface

ELEMENT	WEIGHT (%)
C K	9.32 (10.23)
Al K	-
Ti K	89.53 (11.77)

No aluminum was detected

Results are expressed as the mean and standard deviation of the mass percentage (WEIGHT %).

Surface roughness analysis

The roughness study was conducted with a Sensofar S NEOX interferometric-confocal microscope (Sensofar Medical, Terrasa, Spain) and SensoMAP Premium 7.4 software. The quantitative roughness profile parameters applied were: average roughness (Ra), root-mean-square roughness (Rq), maximum profile peak height roughness (Rp) and maximum profile valley depth roughness (Rv).

Ra (µm) (SD)	Rq (µm) (SD)	Rp (µm) (SD)	Rv (µm) (SD)
0.82 (0.10)	0.97 (0.08)	1.84 (0.04)	2.21 (0.01)

The 3D surface roughness (Sa), 3D root mean square height (Sq), maximum 3D peak height (Sp) and maximum 3D pit depth of the selected area (Sv) were also recorded.

Sa (µm) (SD)	Sq (µm) (SD)	Sp (µm) (SD)	Sv (µm) (SD)
0.76 (0.01)	0.97 (0.01)	4.20 (0.12)	4.62 (0.20)

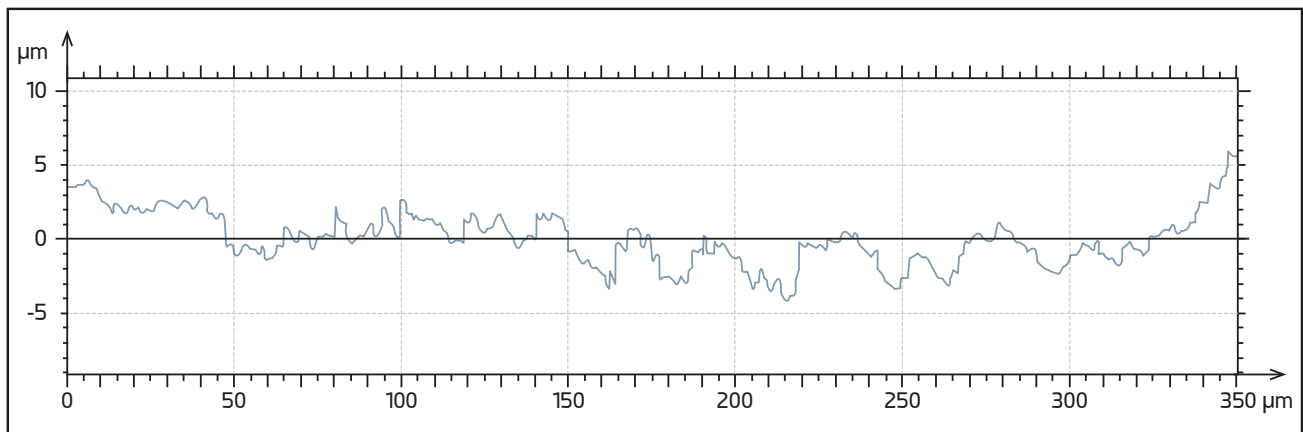

The data were extracted from:

Rizo-Gorrita, M.; Fernandez-Asian, I.; Garcia-de-Frenza, A.; Vazquez-Pachon, C.; Serrera-Figallo, M.; Torres-Lagares, D.; Gutierrez-Perez, J. Influence of Three Dental Implant Surfaces on Cell Viability and Bone Behavior. An In Vitro and a Histometric Study in a Rabbit Model. *Appl. Sci.* 2020. 10(14), 4790

■ OPTIMAL OSSEOINTEGRATION

The **Titansure** surface has a three-dimensional surface structure with high peaks and broad troughs, which is known to be highly effective at promoting the coagulation cascade and the release of growth factors through platelet activation [Kim, H.; Choi, S.H.; Ryu, J.J.; Koh, S.Y.; Park, J.H.; Lee, I.S. The biocompatibility of SLA-treated titanium implants. *Biomed. Mater.* 2008. 3. 025011].

This type of surface may have an osteogenic effect thanks to its different topographical features at a micrometer and nanometer level, which has a very similar morphology to the osteoclastic bone resorption cavities [Le Guehennec, L.; Goyenvalle, E.; Lopez-Heredia, M.A.; Weiss, P.; Amouriq, Y.; Layrolle, P. Histomorphometric analysis of the osseointegration of four different implant surfaces in the femoral epiphyses of rabbits. *Clin. Oral Implants Res.* 2008. 19. 1103–1110].

For more information on the surface treatment see the literature available at www.ziacom.com/biblioteca





ZM4 implants

Product presentation

■ Blister packaging

Available for implants with **Titansure** surface treatment. Blister packs are heat sealed and include product labels in order to be able to trace products correctly and a flap for easy opening in the clinic but while preventing accidental opening.



IMPORTANT

Do not open the sterile container until just before inserting the implant.

■ ZPlus mount

Options for the ZM4 include the **ZPlus** mount, a multi-functional abutment made from grade 5 ELI titanium (medical grade), which allows easy handling of the implant during surgical procedures. In addition, the **ZPlus** mount concept is based on reducing treatment costs, as it works equally well as as an implant mount, impression abutment or provisional abutment for cement- or screw-retained restorations.

The **ZPlus** mount is available for the following implant ranges Zinic®, Zinic® MT, ZM4, ZM4 MT and ZM1.

As already indicated, the **ZPlus** mount can be used as a provisional abutment. In this case, the **ZPlus** should be prepared extraorally by seating it on the analogue, preferably on a laboratory model, or by attaching it to a holder. Check also the structural integrity of the mount and screw, to ensure that they have not suffered any deformation or damage due to excessive insertion torque or forced removal manoeuvre. Additionally, verify on an analogue that the **ZPlus** fixation screw is well seated and that the connection is secure.

IMPORTANT

Always follow the surgical protocol when inserting the implant. This will protect the mount and screw from possible damage which could prevent its being used later as an impression and/or provisional abutment. Use each **ZPlus** only with the implant to which it belongs. To avoid mix-ups, keep the **ZPlus** and screw with the patient's ID, detailing the corresponding reference and lot number. The **ZPlus** has 3 flat sides. After inserting the implant, make sure one of these flat sides faces the labial direction.

Uses of ZPlus mount

As an implant mount

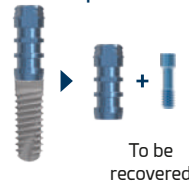

As an impression abutment

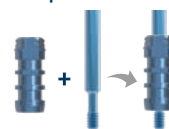

As a provisional abutment

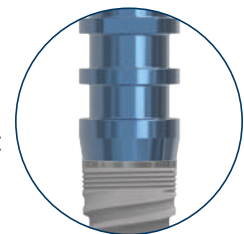
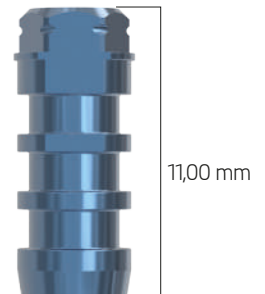

View of implant + mount

Outer identification label

Ziacom® implants are supplied in a sealed cardboard box that includes a product identification label with a description of their main characteristics.

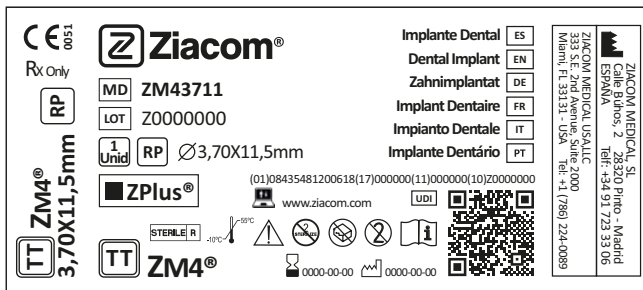

Description of the symbology used

- CE MDD CE certification and notified body
- MD Name of the medical device
- LOT Number of product batch
- Patient information website
- UDI Unique device identification
- STERILISED Sterilised using radiation
- Temperature restriction
- Caution, consult accompanying documents
- Do not resterilise
- Do not use if the packaging is damaged
- Non-reusable product
- Consult the instructions for use
- Expiry date of the product
- Date of manufacture
- Product manufacturer
- TT Titansure surface treatment
- TT Titansure Active surface treatment
- Rx Only Caution: federal law prohibits dispensing without prescription

For full details on the product presentation and instructions for use (IFU) see www.ziacom.com/ifus or scan the QR code on the box.



References of ZM4 with ZPlus - Titansure

IMPLANT

	Ø (mm)	Ø Core (mm)	Length (mm)	Ref. Titansure	
ZM4	3.30	2.80/2.50	10.0	ZM43310	
			11.5	ZM43311	
			13.0	ZM43313	
			14.5	ZM43314	
3.70	3.20/2.80	8.5	ZM43785		
		10.0	ZM43710		
		11.5	ZM43711		
		13.0	ZM43713		
4.00	3.40/3.05	14.5	ZM43714		
		8.5	ZM44085		
		10.0	ZM44010		
		11.5	ZM44011		
4.30	3.70/3.30	13.0	ZM44013		
		14.5	ZM44014		
		8.5	ZM44385		
		10.0	ZM44310		
4.60	3.90/3.55	11.5	ZM44311		
		13.0	ZM44313		
		14.5	ZM44314		
		8.5	ZM44685		
5.00	4.15/3.75	10.0	ZM44610		
		11.5	ZM44611		
		13.0	ZM44613		
		8.5	ZM45085		
		10.0	ZM45010		
		11.5	ZM45011		
		13.0	ZM45013		

Size



Sizes: 1.80 (NP) and 2.00 (RP/WP).

Cover screw*



Platf.	Length (L)	Reference
	5.00	OEXNPT
	5.00	OEXRPT
	4.90	OEXWPT

Anodising NP RP WP



* Screw included with each implant.

Platform

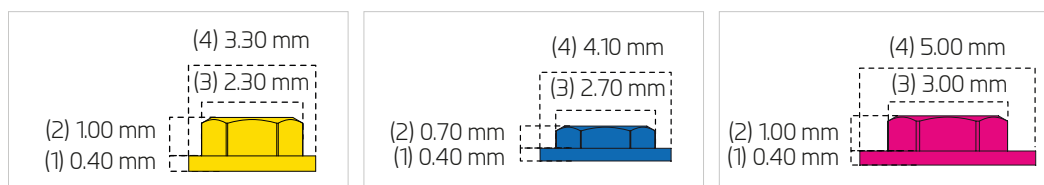

(1) Untreated machined area. (2) External hex height. (3) Distance between faces of the external hex. (4) Diameter of working platform.

Recommendations for use

All implant treatments must respect the natural biomechanical stability of the oral cavity and allow the natural emergence of the dental crown through the soft tissue. The implantologist must assess the quantity and quality of bone currently in the implant area and consider the need for prior or simultaneous bone regeneration, as appropriate.

Ziacom® has a wide range of implants available to cover every reconstruction possibility. The squares on the periodontal chart represent the implant diameters and platforms recommended for each tooth position.

These recommendations are valid for replacing teeth with single-unit restorations, bridges, hybrid dentures or overdentures.

Remember to maintain minimum distances between adjacent implants and between implants and teeth in order to preserve interdental papilla, bone vascularisation and natural emergence profiles.

Selection of the appropriate implant for each case is the sole responsibility of the implantologist. Ziacom® recommends that clinicians take into account the scientific evidence-based warnings given in the product catalogues and on our website.

■ CLARIFICATIONS ON DRILLING MEASUREMENTS AND TECHNIQUES

- **IMPLANT SIZE:** identifies the diameter and length of the implant.
- **IMPLANT BODY:** diameter of the implant core.
- **DRILL SIZE:** diameter of the drill.
- **DRILLING TECHNIQUE:** we have developed various drilling protocols to enable you to deal with different situations that arise in a schematic way when performing implant surgery.

Periodontal chart

ZM4

Implant diameter⁽¹⁾

■ NP ■ A RP ■ B RP ■ C RP ■ WP ■ WP
 Ø3.30 mm Ø3.70 mm Ø4.00 mm Ø4.30 mm Ø4.60 mm Ø5.00 mm
 (1) Diameters available for analogue platforms

Implant crown diameter

■ NP ■ RP ■ WP
 Ø3.30 mm Ø4.10 mm Ø5.00 mm

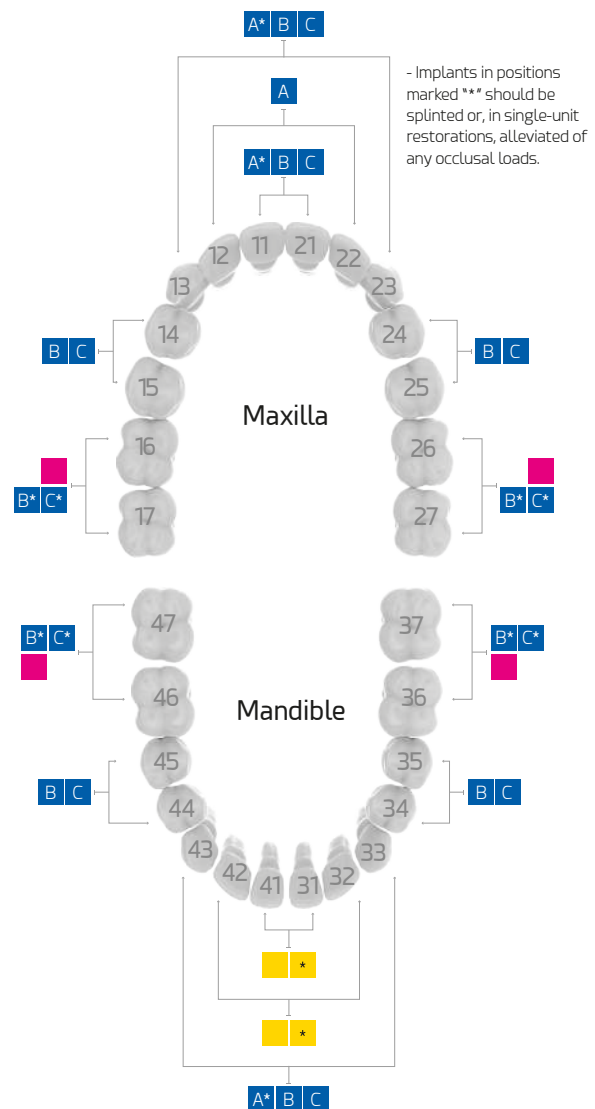

For more information on implant size selection see the literature available at www.ziacom.com/biblioteca



Surgical
protocol

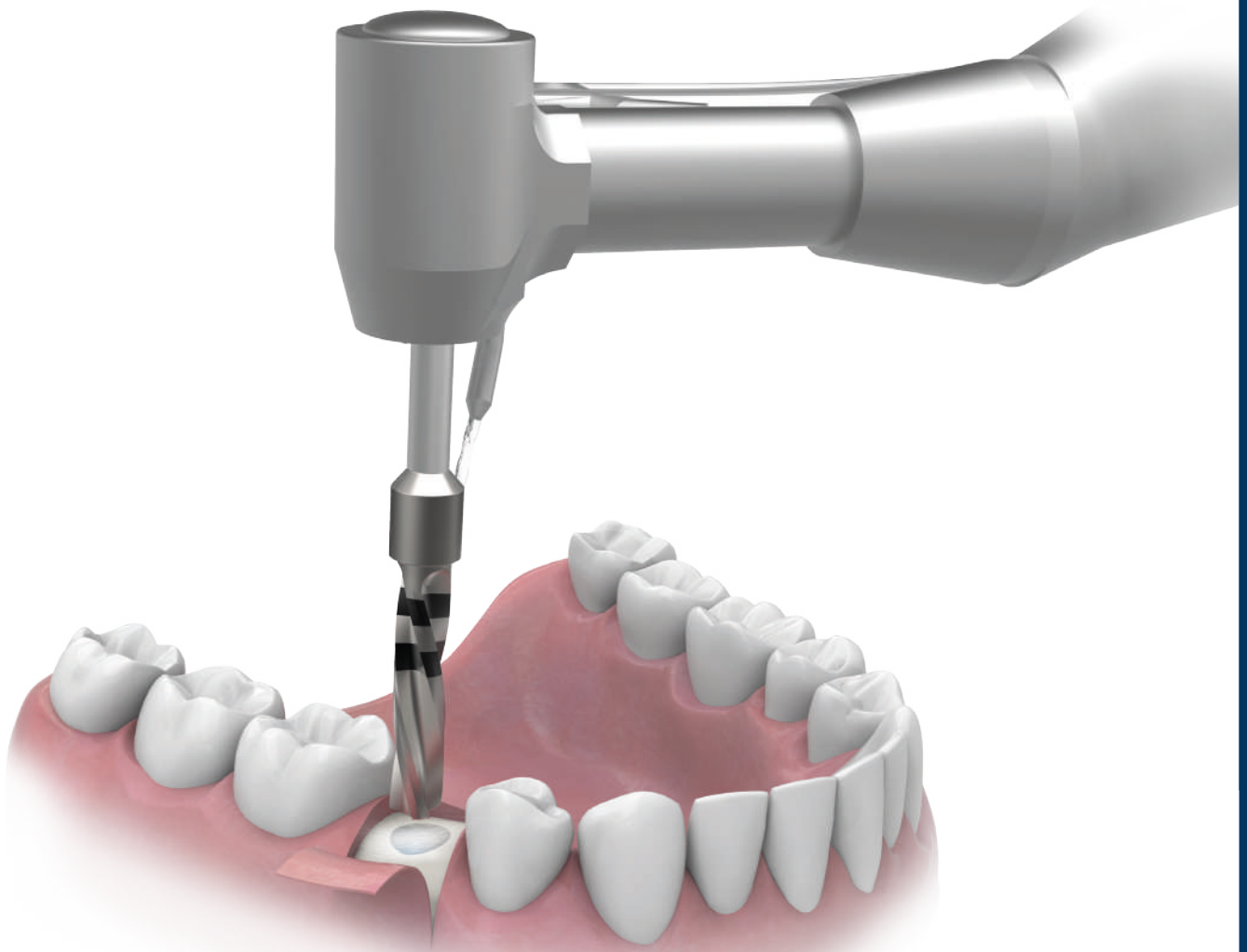

Surgical protocol

General considerations

■ Ziacom® drill system

Ziacom® implant system drills are made from stainless steel. The drills should be handled carefully to avoid any damage that could compromise their effectiveness. It is important to make sure the drills are in good condition. If you are unsure about the condition of any instrument, do not use it.

■ DRILLING SEQUENCE INDICATIONS

- Drills must be inserted into the contra-angle handpiece with the motor stopped, ensuring that they are seated and rotate properly before starting drilling.
- Drills should be used with external irrigation.
- The speed and torque recommended for each drill should be respected. (See surgical protocol).
- Position the drill at the chosen implant insertion site before starting drilling.
- Perform controlled tapping movements, drilling the bone to the desired depth, guided by the reference depth laser marking.
- Remove the drill from the surgical site with the motor running.

NOTES

- Do not continue drilling without irrigation.
- If using a drill extender, supplement irrigation manually.
- For surgical and cortical drills, a maximum of 45 uses is recommended per drill. Exceeding the recommended number of uses puts the implant osseointegration process at risk.
- If any damage to the drill is observed, do not use it and replace with a new drill.
- Sterilise the instruments after each use in accordance with the cleaning and sterilisation instructions (page 24). The drills should be handled carefully to avoid any damage that could compromise their effectiveness. It is important to make sure the drills are in good condition. If you are unsure about the condition of any instrument, do not use it.

■ Surgical drills

The Ziacom® surgical drill length measurement system is simple and guides you during the surgical site drilling process.

The laser marking on the drill shank identifies its diameter, while the horizontal laser-marked band on the active section corresponds to the length of the different implants (mm-graduated drills).

The drill tip is 0.5 mm long and this is not included in the different laser-marked lengths. When placing the implant using a flapless procedure, measure the thickness of the soft tissue with a periodontal probe and add this measurement to the drilling depth.

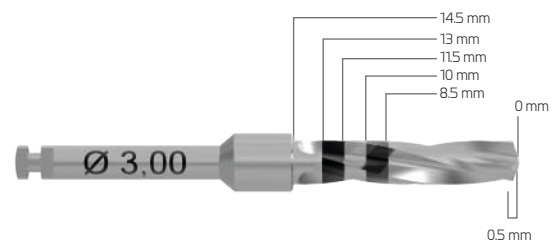

■ Surgical taps

Use of the surgical tap to make each implant's thread is dependent on the type of bone. Taps for use with contra-angle handpieces and manual tools are available. The choice of tap will depend on the individual case and the professional's preference. The laser marking on the tap shank identifies its diameter, while the horizontal laser-marked band on the active section corresponds to the length of the different implants.

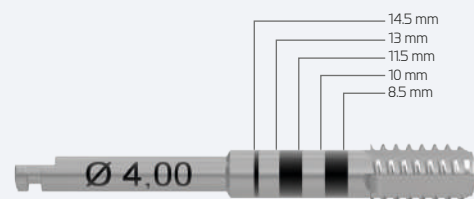

■ Cortical drills

Use of the cortical drill to shape the coronal area of the implant site is dependent on the type of bone. (See surgical protocol).

The laser marking on the cortical drill shank identifies its diameter, while the horizontal laser marking on the active section corresponds to the insertion limit of the cortical drill in the implant site.



■ Drill stops

The Ziacom® drill stop system has been created to simplify the drilling sequence, ensuring osteotomy depth control.

The stops have two laser markings. The first represents the length of the implant to be inserted, and therefore the drilling depth, and the second indicates which drill is to be used.

WARNING

When using a drill with a stop, the length of the drill tip should be taken into consideration as the stops are calibrated to the actual length of the laser markings, not including the length of the drill tip.

The drill stops use a friction locking system. To assemble, place the grooved area of the stop over the drill tip and push it up until it is seated against the drill and locks with friction, as shown in the drawing below. The laser-marked line on the drill and the stop should line up with the selected length.



■ Probe

Check the depth of the surgical site, especially when not using drill stops. To check the surgical bed axis, the paralleling pins are available in different diameters according to the drilling sequence.

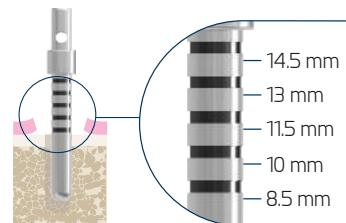

■ Short and long insertion tools for ratchets and contra-angle handpieces

The insertion tool for contra-angle handpieces or ratchets has been designed for transporting implants from their No Mount vial to the surgical site ready for insertion.

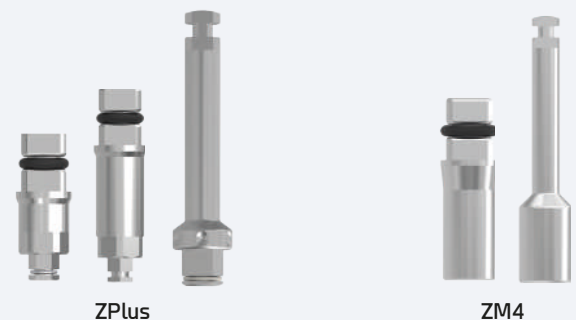

Surgical protocol

Steps of drilling protocol

ZM4 implant

ZM4

- EXAMPLE:
ZM4 implant
Ø4.00x11.50mm
- RP (Ø4.00 mm)
Platform Ø 4.10mm



PRELIMINARY STEP | Opening the gum

Make an incision and lift the flap.

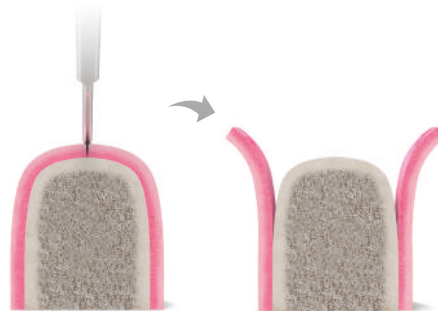

STEP 1 | Lance drill

Start the surgical site drilling sequence using mm-graduated lance drill Ref. SID00 until its stop (length 6.5 mm) or mm-graduated lance drill Ref. MSID00 or lance drill Ref. MSID00T with stop. Control the direction and angle of drilling by applying intermittent pressure vertically, taking care not to exert too much pressure on the bone. If necessary, use drill extender Ref. DEXT10.



STEP 2 | Pilot drill Ø2.30

Continue the drilling sequence using pilot drill Ref. OSPD23 until the length of the chosen implant is reached. Use the length-indicating laser mark on the drill or use drill stop Ref. NTPD115.

Control the direction and angle of drilling by applying intermittent pressure vertically, taking care not to exert too much pressure on the bone. If necessary, use drill extender Ref. DEXT10.



STEP 3 | Probe/Paralleling pin Ø2.30

Check the depth of the surgical site and the insertion axis by inserting probe/paralleling pin Ref. MUR100. Repeat this step as many times as necessary during the surgery.



STEP 4 | Final drill Ø2.80

Continue the drilling sequence using Ø2.8mm surgical drill Ref. OSTD28 until the length of the chosen implant is reached.

Use the length-indicating laser mark on the drill or use drill stop Ref. NTPD115.

Control the direction and angle of drilling by applying intermittent pressure vertically, taking care not to exert too much pressure on the bone. If necessary, use drill extender Ref. DEXT10.



STEP 5 | Final drill Ø3.00

Continue the drilling sequence using Ø3.0mm surgical drill Ref. OSTD30 until the length of the chosen implant is reached.

Use the length-indicating laser mark on the drill or use drill stop Ref. NTPD115. Control the direction and angle of drilling by applying intermittent pressure vertically, taking care not to exert too much pressure on the bone. If necessary, use drill extender Ref. DEXT10.



STEP 6 | Probe/Paralleling pin Ø3.00

Check the depth of the surgical site and the insertion axis by inserting probe/paralleling pin Ref. MUR200. Repeat this step as many times as necessary during the surgery.



STEP 7 | Final drill Ø3.25

Continue the drilling sequence using Ø3.25mm surgical drill Ref. OTD32 until the length of the chosen implant is reached. Use the length-indicating laser mark on the drill or use drill stop Ref. NTPD215. Control the direction and angle of drilling by applying intermittent pressure vertically, taking care not to exert too much pressure on the bone. If necessary, use drill extender Ref. DEXT10.



STEP 8 | Probe/Paralleling pin Ø3.25

Check the depth of the surgical site and the insertion axis by inserting probe/paralleling pin Ref. MUR300. Repeat this step as many times as necessary during the surgery.



STEP 9 | Tap

Place the Ø4.0mm surgical tap in the surgical site. Apply firm pressure and start to turn slowly. Once threads engage, continue to screw the tap in without pressure to the planned depth. If excessive resistance is met, turn 90° anti-clockwise after each complete turn. To remove the tap, turn it anti-clockwise. The tap Ref. TAPST40 can be used manually with ratchet Ref. RATC50 or with contra-angle Ref. MTAPST40.



Use of the tap will depend on the type of bone:



Type I	Total
Type II	2/3
Type III - IV	Not required

STEP 10 | Cortical drill

Use cortical drill Ref. STD41 to shape the coronal area of the implant site. Insert the drill as far as its laser marking.

Control the direction and angle of drilling by applying intermittent pressure vertically, taking care not to exert too much pressure on the bone. If necessary for this step, use drill extender Ref. DEXT10.



Use of the cortical drill will depend on the type of bone:



Type I	Mandatory
Type II	Depends on cortical thickness
Type III - IV	Not required

Surgical protocol

Implant insertion using ZPlus Mount | Titansure

ZPlus Mount

Surface treatment

Titansure

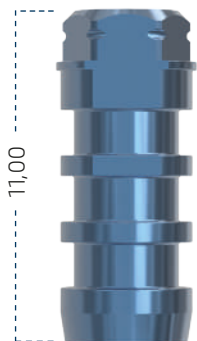

STEP 1 | Unpacking the implant

- 1.1 Press the word "PRESS" and open the implant carton.
- 1.2 Remove the top of the carton and take out the blister pack.
- 1.3 Carefully remove the seal from the blister pack.
- 1.4 Turn the vial containing the implant out onto a sterile cloth in the operating area.
- 1.5 Remember to remove the label from the implant and to adhere it to the patient's implant card and medical record to ensure that the product is traceable.



STEP 2 | Choosing the right placement instrument

Based on the specific clinical situation and access to the surgical site, one of three different instruments can be selected to insert the implant:

- Contra-angle:** select the ZPlus CA driver of the desired length (Ref. 01MMIN / 02MMIN) and insert it into the contra-angle.
- Ratchet Ref. RATC50:** select the ZPlus Ratchet/Manual driver of the desired length (Ref. XSMIN / TSMIN / TLMIN) and insert it into the ratchet set to function "IN", which is identified with an arrow.
- Screwdriver handle 4x4 Ref. MADW10:** select the ZPlus Ratchet/Manual driver of the desired length (Ref. XSMIN / TSMIN / TLMIN) and insert it into the screwdriver handle.

STEP 3 | Removing the implant from its vial

Hold the vial containing the implant in one hand and insert the selected driver into the ZPlus mount with the other hand. Remove the implant-mount assembly by lifting it vertically out of the vial.

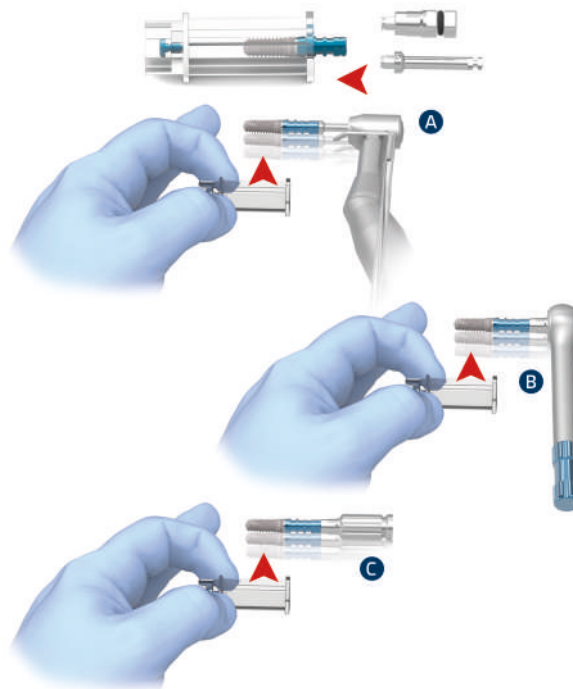

STEP 4 | Inserting the implant

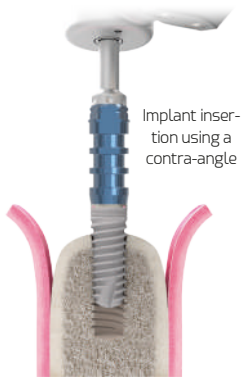

Insert the implant into the surgical site, controlling both the direction and angle of the implant. When inserting the implant with a contra-angle, use a maximum speed of 25 rpm. The recommended insertion torque ranges from 35 to 50 Ncm according to each case and is not limited to a single torque.

If resistance is met during insertion, turn the implant slightly anti-clockwise and then continue to insert after waiting a few seconds. Repeat this process as many times as necessary.

The Ziacom® surgical protocol establishes crestal positioning of the implant platform.

The ZPlus mount has 3 flat sides. After inserting the implant, make sure that one of these flat sides faces the vestibular direction.

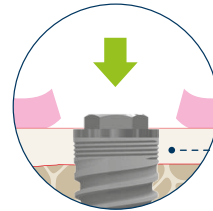

The Ziacom® surgical protocol establishes crestal positioning of the implant platform.

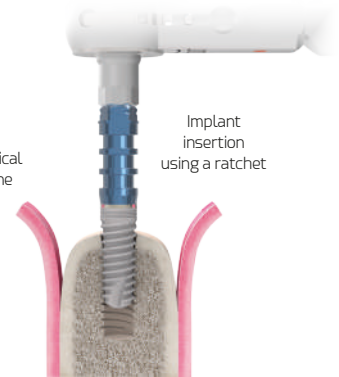

STEP 5 | Extracting the ZPlus Mount

Lock the ZPlus mount using locking key Ref. 01MOHW and remove the screw using manual surgical screwdriver Ref. SMSD / LMSD. After removing the screw, remove the ZPlus by hand.

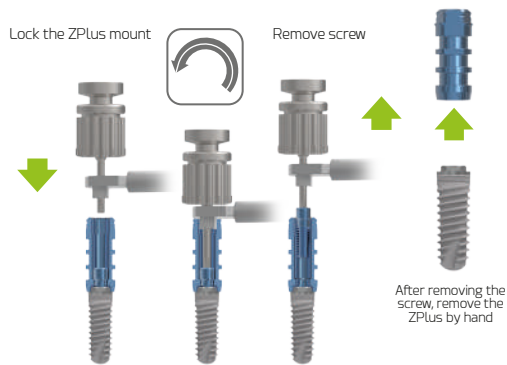

Simplified surgical protocol

Drilling protocol - ZPlus

Rotation Irrigation required Drill diameter Torque

The specified speeds are recommended

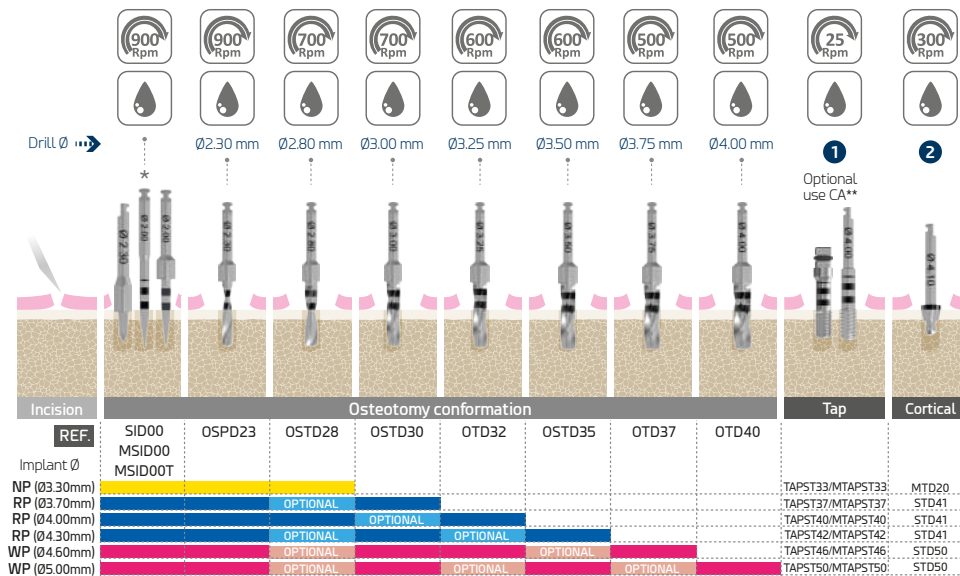

*When drilling Type I/Type II bone, increase the speeds indicated above by 200 rpm. Use mm-graduated lance drill MSID00/MSID00T before using the pilot drill.

UNDERDRILLING: assess in Type III and IV bone.

IMPORTANT: control the drilling axis by applying intermittent pressure (tapping), always in the vertical plane, taking care not to exert excessive pressure on the bone.

TAP AND CORTICAL DRILL

1 Tap usage

According to bone type

Manual or contra-angle (CA)

Type I	Total
Type II	2/3
Type III - IV	Not required

**If the contra-angle option is chosen, take note of the maximum rotating speed limit.

2

Cortical drill usage

According to bone type

Type I	Total
Type II	Depends on cortical thickness
Type III - IV	Not required

Implant insertion - ZPlus

■ Insertion

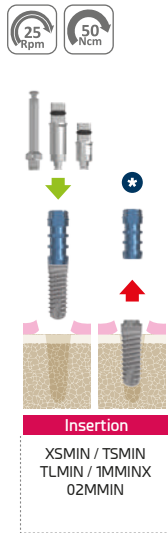

■ Removing the mount *

Insertion point at which to remove the mount according to bone type

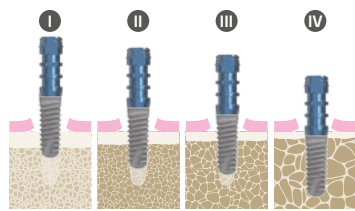

Type I	1/2 insertion
Type II	3/4 insertion
Type III	4/5 insertion
Type IV	Complete insertion

Screw removal

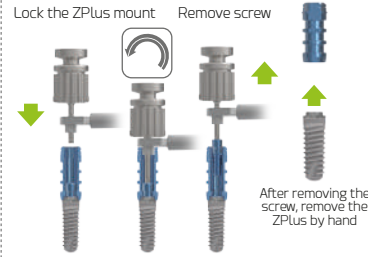

REF. SMSD/LMSD with 01MOHW

IMPORTANT

Important: if the ZPlus has seized on the implant, use the extractor screw to remove it: with NP platform, use Ref. EDSZ20 and with RP/WP platform, use Ref. EDSZ34

■ Direct insertion



Insertion

It has direct insertion keys to the implant ref.: SMEX20/SMEX34/SMEX50, for ratchet/manual and MMEX20/MMEX34/MMEX50 for CA, to adjust the implant end-position.

■ Crestal placement

The Ziacom® implant platform should be placed at bone crest level.

RECOMMENDED crestal position

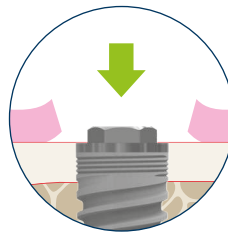

■ Bone types

Clasificación de Lekholm y Zarb (1985)



TYPE IV BONE - SOFT BONE

- Thin cortical layer surrounding a low-density trabecular bone.



TYPE II & III BONE - MEDIUM BONE

- Type II: thick layer of compact bone surrounding a dense trabecular bone.
- Type III: thin cortical layer surrounding a dense trabecular bone.



TYPE I BONE - HARD BONE

- Composed almost entirely of homogeneous compact bone.

Simplified surgical protocol

General recommendations

Consider during intervention



Surgical drills must be inserted into the contra-angle handpiece with the motor stopped, ensuring that they are seated and rotate properly before starting drilling. Treat drills with the utmost care; the slightest damage to the tips could compromise their effective operation.



Each instrument should only be used for the specific use recommended by the manufacturer.



Damaged instruments must be disposed of according to local regulations.



Implantologists should keep one of the identification labels supplied with the product in the patient's file so that it may be traced correctly.

Handling of cover screw

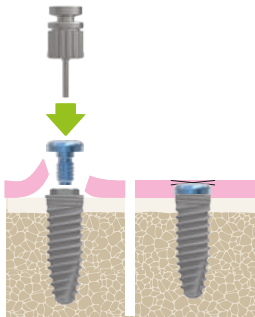

Remove the cover screw from its vial using the hex screwdriver in a counter-clockwise direction. Move the cover screw towards the implant while taking care not to drop it and cause its accidental ingestion. Insert the cover screw into the implant and tighten it using manual torque in a clockwise direction.

Preparation for second surgical phase

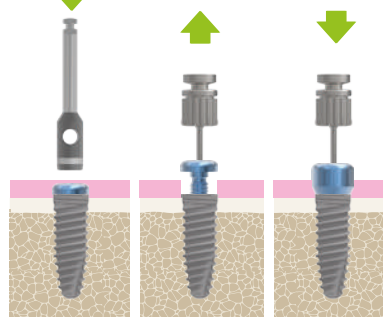

Placement of healing abutment

The healing abutment should correspond to the implant platform, considering the option of applying the platform switch technique with anatomical abutments and be in accordance with the height of the gingival tissue to avoid abutment occlusion. Excessive height could expose the implant to premature loading, compromising the osseointegration process.

IMPORTANT WARNINGS

About implant insertion

Excessive compression of the bone can lead to failure of implant osseointegration.

Failure to follow the steps described in the surgical sequence may result in:

- Lack of primary stability due to loss of supporting bone.
- Difficulties during implant insertion.

Exceeding the torque (50 Ncm) when inserting the implant may result in:

- Irreversible deformation of the implant's internal/external connection.
- Irreversible deformation of the implant insertion instrument.
- Difficulty disassembling the instrument/implant assembly.

Maximum insertion torque and speed

The recommended insertion torque ranges from **35 to 50 Ncm**, according to each case, and is not limited to a single torque.



The implant should be inserted with controlled torque based on the bone density and quality of the implant placement site:

Without partial or complete **disassembly of the implant Mount**, in **type III and IV bone, respectively**, with recommended torque of **35 to 50 Ncm** to avoid deformation of the Mount or cold welding between the Mount and the implant.

With partial or complete **disassembly of the implant Mount** and using a direct-to-implant key, in **type I and II bone, respectively**, with recommended torque of **35 to 50 Ncm** to avoid deformation of the connection and excessive bone compression.

Insertion instrument or CA screwdrivers: use a maximum speed of:



ZM4 implants

The Ziacom® surgical protocol establishes the crestal position of the implant platform.

To avoid cortical stress and deformation of the key and/or implant connection, and also to avoid galling between the implant and the Mount, the recommended maximum speed (**25 Rpm**) and maximum torque (**50 Ncm**) must be respected when inserting with a contra-angle (CA) handpiece.

When using a ratchet, it is necessary to monitor resistance during insertion. If there is any resistance, the implant should be removed by turning it twice (to release the bone from the tension created and free the thread) and then, after a few seconds, the implant should be inserted again, repeating this process as many times as is necessary.

Always consult the surgical and prosthetic protocols published in this catalogue, as well as the other documents available in the "Reference literature" section of our website www.ziacom.com/biblioteca which explained the procedures, protocols and instructions for use before using the ZM4 system by Ziacom®.



Cleaning, disinfection and sterilisation



Cleaning, disinfection and sterilisation

The protocols described in this section must only be carried out by personnel qualified to clean, disinfect and sterilise the dental materials specified here in.

Cleaning and disinfection instructions

Applicable for instruments, surgical and prosthetic boxes and plastic retainer caps.

■ Disassembly

1. Dismount* the appropriate instruments, for example manual ratchets, drills or drill stops.
2. Remove the various components from the surgical or prosthetic box for correct cleaning.

■ Cleaning and disinfection

For disinfecting instruments and surgical boxes:

1. Submerge the instruments in a detergent/disinfectant solution** suitable for dental instruments to help eliminate any adhered biological residues. If an ultrasound bath is available***, confirm that the detergent/disinfectant solution is indicated for use with this type of equipment.
2. Manually remove any biological residues with a non-metallic brush and pH-neutral detergent.
3. Rinse with copious water.
4. When cleaning the surgical and prosthetic boxes, always use a pH-neutral detergent and non-abrasive utensils to avoid damaging the surface of the boxes.
5. Dry the materials with disposable cellulose, lint-free clothes or compressed air.

For disinfecting plastic caps and spacers:

1. Submerge in a neat benzalkonium chloride solution for 10 minutes.
2. Rinse with distilled water.
3. Dry the caps and spacer before use.

■ Inspection

1. Check that the instruments are perfectly clean; if not, repeat the cleaning and disinfection steps.
2. Discard any instruments with imperfections and replace them before the next procedure.
3. Check that the instruments and the surgical and prosthetic boxes are perfectly dry before reassembling the parts and proceeding to their sterilisation.

* See the assembly disassembly manuals at www.ziacom.com/biblioteca

** Follow the instructions from the disinfectant's manufacturer to determine the correct concentrations and times.

*** Follow the instructions from the ultrasound bath's manufacturer to determine the correct temperature, concentration and times.

Sterilisation instructions for steam autoclave

Applicable to orthodontic implants, abutments, and surgical and prosthetic instruments and boxes.

1. Introduce each material separately in individual sterilisation bags, then seal the bags. For joint sterilisation, place the instruments in their surgical box, introduce the box into a sterilisation bag and seal the bag.
2. Place the bags to be sterilised in the autoclave.
3. Sterilise in a steam autoclave at 134°C/273°F (max. 137°C/276°F) for 4 min (minimum) and at 2 atm. Torque wrenches must be sterilised in 3 vacuum cycles at 132°C/270°F for a minimum of 1.5 minutes and vacuum-dried for a minimum of 20 minutes.

For the United States only: The validated and recommended sterilisation cycle for the US must be performed in a steam autoclave at 132°C/270°F for at least 15 min and with the drying time of at least 15 - 30 min.

IMPORTANT

Make sure the drying stage is allowed to run to completion, otherwise the products may be damp.

Check the sterilisation equipment if the materials or sterilisation bags are damp at the end of the sterilisation cycle.

Perform the necessary maintenance actions on the autoclave according to the established periodicity and following the manufacturer's instructions.



Storage of Ziacom® products

- Store the products in their original packaging and in a clean, dry location until they are used.
- After sterilisation, keep the products in the sealed sterilisation bags and in a clean, dry location.
- Never exceed the use by date indicated by the manufacturer of the sterilisation bags.
- Always follow the indications of the manufacturer of the sterilisation bags.

General recommendations

- Never use damaged or dirty material; never reuse single-use products. The user is responsible for following the instructions described in this document correctly.
- The attention to piercing or sharp elements. Gloves should be worn when cleaning the materials to avoid accidents during handling.
- Follow the safety instructions indicated by the manufacturer of the disinfectant agent.
- The product's sterility cannot be guaranteed if the sterilisation bag is open, damaged or damp.
- Respect all stages of the sterilisation process. If the materials or sterilisation bags contain traces of water or moisture, check the autoclave and repeat the sterilisation.
- Orthodontic abutments and implants are supplied UNSTERILISED and must always be sterilised before use.
- Instruments and surgical and prosthetic boxes are supplied UNSTERILISED and must always be sterilised before use and cleaned and disinfected after use.
- The sterilisation, cleaning and disinfection processes gradually deteriorate the instruments. Inspect the instruments thoroughly to detect any signs of deterioration.
- Avoid contact between products made from different materials (steel, titanium, etc.) during the cleaning, disinfection and sterilisation processes.
- Ziacom Medical SL recommends these instructions are implemented for the correct maintenance and safety of their products; accordingly, the company refuses any liability for any damage to the products that could arise if the user applies alternative cleaning, disinfection and sterilisation procedures.

See www.ziacom.com/biblioteca for the latest version of the cleaning, disinfection and sterilisation instructions.



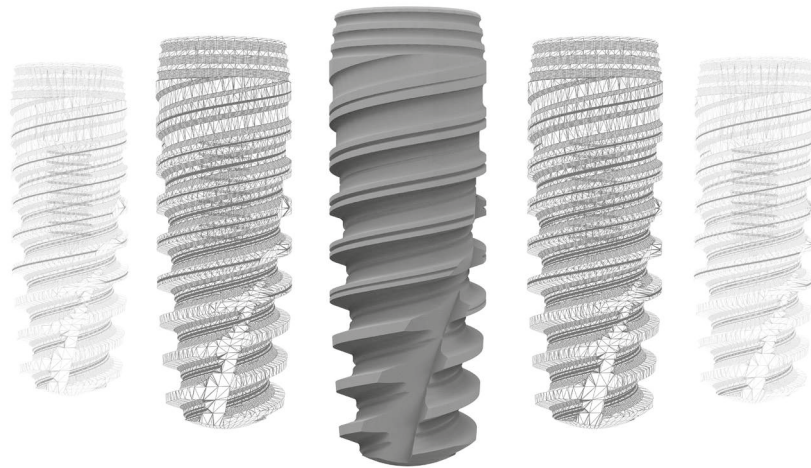

See the latest version of the general conditions of sale on our website www.ziacom.com.

Check the availability of each product in your country.

All rights reserved. No part of this document may be reproduced or stored in any medium or reproduction system, nor transmitted in any way or under any concept, electronically, mechanically, in photocopies, recording or any other mean not considered here without the permission of holder of the copyright, editing and printing. Ziacom® is a registered trademark of Ziacom Medical SL.

See the latest version of the catalogues available at www.ziacom.com.



www.ziacom.com

Ziacom Medical SL

Calle Búhos, 2
28320 Pinto - Madrid - ESPAÑA
Tfno.: +34 91 723 33 06
info@ziacom.com

Ziacom Medical Portugal Lda

Av. Miguel Bombarda, 36 - 5º B
1050 -165 - Lisboa - PORTUGAL
Tel: +351 215 850 209
info.pt@ziacom.com

Ziacom Medical USA LLC

333 S.E 2nd Avenue, Suite 2000
Miami, FL 33131 - USA
Phone: +1 (786) 224 - 0089
info.usa@ziacom.com